

JVC

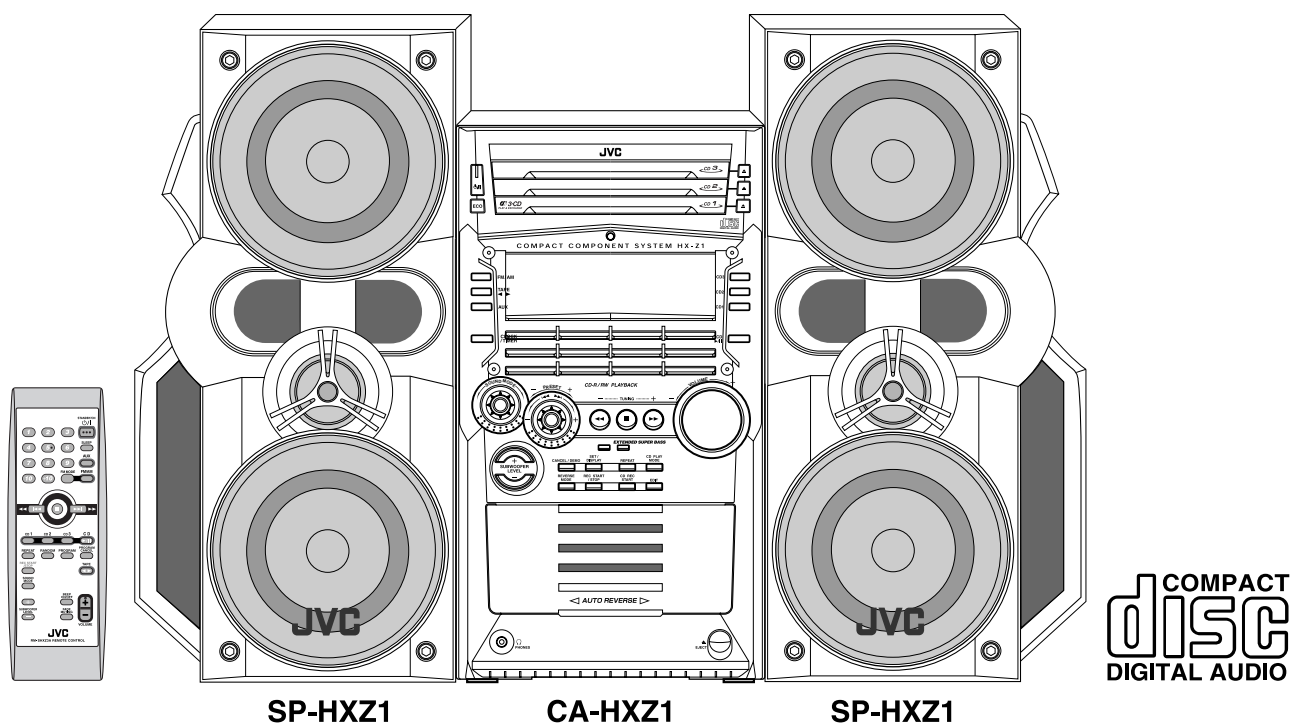

COMPACT COMPONENT SYSTEM

HX-Z1 — Consists of CA-HXZ1 and SP-HXZ1



INSTRUCTIONS

For Customer Use:

Enter below the Model No. and Serial No. which are located either on the rear, bottom or side of the cabinet. Retain this information for future reference.

Model No. _____

Serial No. _____

GVT0077-001A

[J]

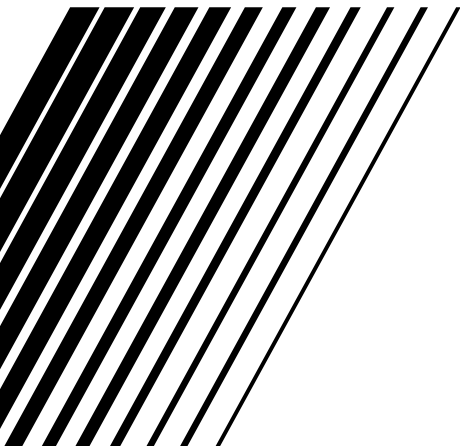

Warnings, Cautions and Others

Mises en garde, précautions et indications diverses

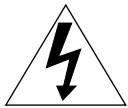

The lightning flash with arrowhead symbol, within an equilateral triangle is intended to alert the user to the presence of uninsulated "dangerous voltage" within the product's enclosure that may be of sufficient magnitude to constitute a risk of electric shock to persons.



The exclamation point within an equilateral triangle is intended to alert the user to the presence of important operating and maintenance (servicing) instructions in the literature accompanying the appliance.

WARNING: TO REDUCE THE RISK OF FIRE OR ELECTRIC SHOCK, DO NOT EXPOSE THIS APPLIANCE TO RAIN OR MOISTURE.

CAUTION

To reduce the risk of electrical shocks, fire, etc.:

1. Do not remove screws, covers or cabinet.
2. Do not expose this appliance to rain or moisture.

ATTENTION

Afin d'éviter tout risque d'électrocution, d'incendie, etc.:

1. Ne pas enlever les vis ni les panneaux et ne pas ouvrir le coffret de l'appareil.
2. Ne pas exposer l'appareil à la pluie ni à l'humidité.

For U.S.A.

This equipment has been tested and found to comply with the limits for a Class B digital device, pursuant to part 15 of the FCC Rules. These limits are designed to provide reasonable protection against harmful interference in a residential installation.

This equipment generates, uses and can radiate radio frequency energy and, if not installed and used in accordance with the instructions, may cause harmful interference to radio communications. However, there is no guarantee that interference will not occur in a particular installation. If this equipment does cause harmful interference to radio or television reception, which can be determined by turning the equipment off and on, the user is encouraged to try to correct the interference by one or more of the following measures:

Reorient or relocate the receiving antenna.

Increase the separation between the equipment and receiver.

Connect the equipment into an outlet on a circuit different from that to which the receiver is connected.

Consult the dealer or an experienced radio/TV technician for help.

Caution— (standby/on) button!

Disconnect the mains plug to shut the power off completely. The  (standby/on) button in any position does not disconnect the mains line. The power can be remote controlled.

Attention—Commutateur (attente/sous tension)!

Déconnecter la fiche de secteur pour couper complètement le courant. Le commutateur  (attente/sous tension) ne coupe jamais complètement la ligne de secteur, quelle que soit sa position. Le courant peut être télécommandé.

For Canada/pour le Canada

CAUTION: TO PREVENT ELECTRIC SHOCK, MATCH WIDE BLADE OF PLUG TO WIDE SLOT, FULLY INSERT.

ATTENTION: POUR EVITER LES CHOCS ELECTRIQUES, INTRODUIRE LA LAME LA PLUS LARGE DE LA FICHE DANS LA BORNE CORRESPONDANTE DE LA PRISE ET POUSSER JUSQU'AU FOND.

For Canada/pour le Canada

THIS DIGITAL APPARATUS DOES NOT EXCEED THE CLASS B LIMITS FOR RADIO NOISE EMISSIONS FROM DIGITAL APPARATUS AS SET OUT IN THE INTERFERENCE-CAUSING EQUIPMENT STANDARD ENTITLED "DIGITAL APPARATUS," ICES-003 OF THE DEPARTMENT OF COMMUNICATIONS.

CET APPAREIL NUMERIQUE RESPECTE LES LIMITES DE BRUITS RADIOELECTRIQUES APPLICABLES AUX APPAREILS NUMIRIQUES DE CLASSE B PRESCRITES DANS LA NORME SUR LE MATERIEL BROUILLEUR: "APPAREILS NUMERIQUES", NMB-003 EDICTEE PAR LE MINISTRE DES COMMUNICATIONS.

1. CLASS 1 LASER PRODUCT
 2. **DANGER:** Invisible laser radiation when open and interlock failed or defeated. Avoid direct exposure to beam.
 3. **CAUTION:** Do not open the top cover. There are no user serviceable parts inside the Unit; leave all servicing to qualified service personnel.
-
1. PRODUIT LASER CLASSE 1
 2. **ATTENTION:** Radiation laser invisible quand l'appareil est ouvert ou que le verrouillage est en panne ou désactivé. Eviter une exposition directe au rayon.
 3. **ATTENTION:** Ne pas ouvrir le couvercle du dessus. Il n'y a aucune pièce utilisable à l'intérieur. Laisser à un personnel qualifié le soin de réparer votre appareil.

Introduction

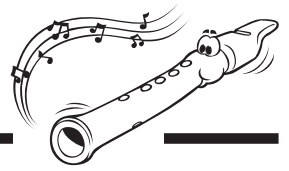

We would like to thank you for purchasing one of our JVC products. Before operating this unit, read this manual carefully and thoroughly to obtain the best possible performance from your unit, and retain this manual for future reference.

About This Manual

This manual is organized as follows:

- The manual mainly explains operations using the buttons and controls on the unit. You can also use the buttons on the remote control if they have the same or similar names (or marks) as those on the unit. If operation using the remote control is different from that using the unit, it is then explained.
- Basic and common information that is the same for many functions is grouped in one place, and is not repeated in each procedure. For instance, we do not repeat the information about turning on/off the unit, setting the volume, changing the sound effects, and others, which are explained in the section “Common Operations” on pages 9 to 11.
- The following marks are used in this manual:



Gives you warnings and cautions to prevent from damage or risk of fire/electric shock. Also gives you information which is not good for obtaining the best possible performance from the unit.



Gives you information and hints you had better know.

Precautions

Installation

- Install in a place which is level, dry and neither too hot nor too cold—between 5°C (41°F) and 35°C (95°F).
- Install the unit in a location with adequate ventilation to prevent internal heat buildup in the unit.
- Leave sufficient distance between the unit and the TV.
- Keep the speakers away from the TV to avoid interference with TV.



DO NOT install the unit in a location near heat sources, or in a place subject to direct sunlight, excessive dust or vibration.

Power sources

- When unplugging from the wall outlet, always pull the plug, not the AC power cord.



DO NOT handle the AC power cord with wet hands.

Moisture condensation

Moisture may condense on the lens inside the unit in the following cases:

- After heating start in the room
 - In a damp room
 - If the unit is brought directly from a cold to a warm place
- Should this occur, the unit may malfunction. In this case, leave the unit turned on for a few hours until the moisture evaporates, unplug the AC power cord, and then plug it in again.

Internal heat

A cooling fan is mounted on the rear panel to prevent heat buildup inside the unit.



For safety, observe the following carefully:

- Make sure there is good ventilation around the unit. Poor ventilation could overheat and damage the unit.
- DO NOT block the cooling fan and the ventilation openings or holes. If they are blocked by a newspaper or cloth, etc., the heat may not be able to get out.

Others

- Should any metallic object or liquid fall into the unit, unplug the unit and consult your dealer before operating any further.
- If you are not going to operate the unit for an extended period of time, unplug the AC power cord from the wall outlet.



DO NOT disassemble the unit since there are no user serviceable parts inside.

If anything goes wrong, unplug the AC power cord and consult your dealer.

Contents

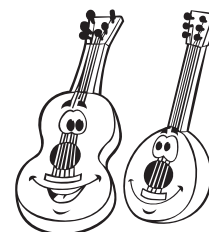

Location of the Buttons and Controls	3
Front Panel	3
Remote Control	5
Getting Started	6
Supplied Accessories	6
Putting the Batteries into the Remote Control	6
Connecting Antennas	6
Connecting Speakers	7
Connecting Other Equipment	8
Canceling the Demonstration	8
Common Operations	9
Turning On or Off the Power	9
Saving the Power Consumption while on Standby	
—Ecology Mode	9
Setting the Clock	9
Selecting the Sources	10
Adjusting the Volume	10
Reinforcing the Bass Sound	10
Selecting the Sound Modes	10
Creating Your Own Sound Mode—User Mode	11
Turning On or Off the Key-touch Tone	11
Listening to FM and AM Broadcasts	12
Tuning in to a Station	12
Presetting Stations	12
Tuning in to a Preset Station	12
Playing Back CDs (CD/CD-R/CD-RW)	13
Loading CDs	13
Playing Back the Entire Discs—Continuous Play ...	14
Basic CD Operations	14
Programming the Playing Order of the Tracks	
—Program Play	15
Playing at Random—Random Play	16
Repeating Tracks or CDs—Repeat Play	17
Prohibiting Disc Ejection—Tray Lock	17
Playing Back Tapes	18
Playing Back a Tape	18
Locating the Beginning of a Song—Music Scan	18
Recording	19
Recording on a Tape	19
CD Synchronized Recording	20
■ CD Direct Recording	20
■ Auto Edit Recording	21
Using the Timers	22
Using Daily Timer	22
Using Recording Timer	24
Using Sleep Timer	25
Timer Priority	25
Maintenance	26
Troubleshooting	27
Specifications	28

Location of the Buttons and Controls

Become familiar with the buttons and controls on your unit.

Front Panel

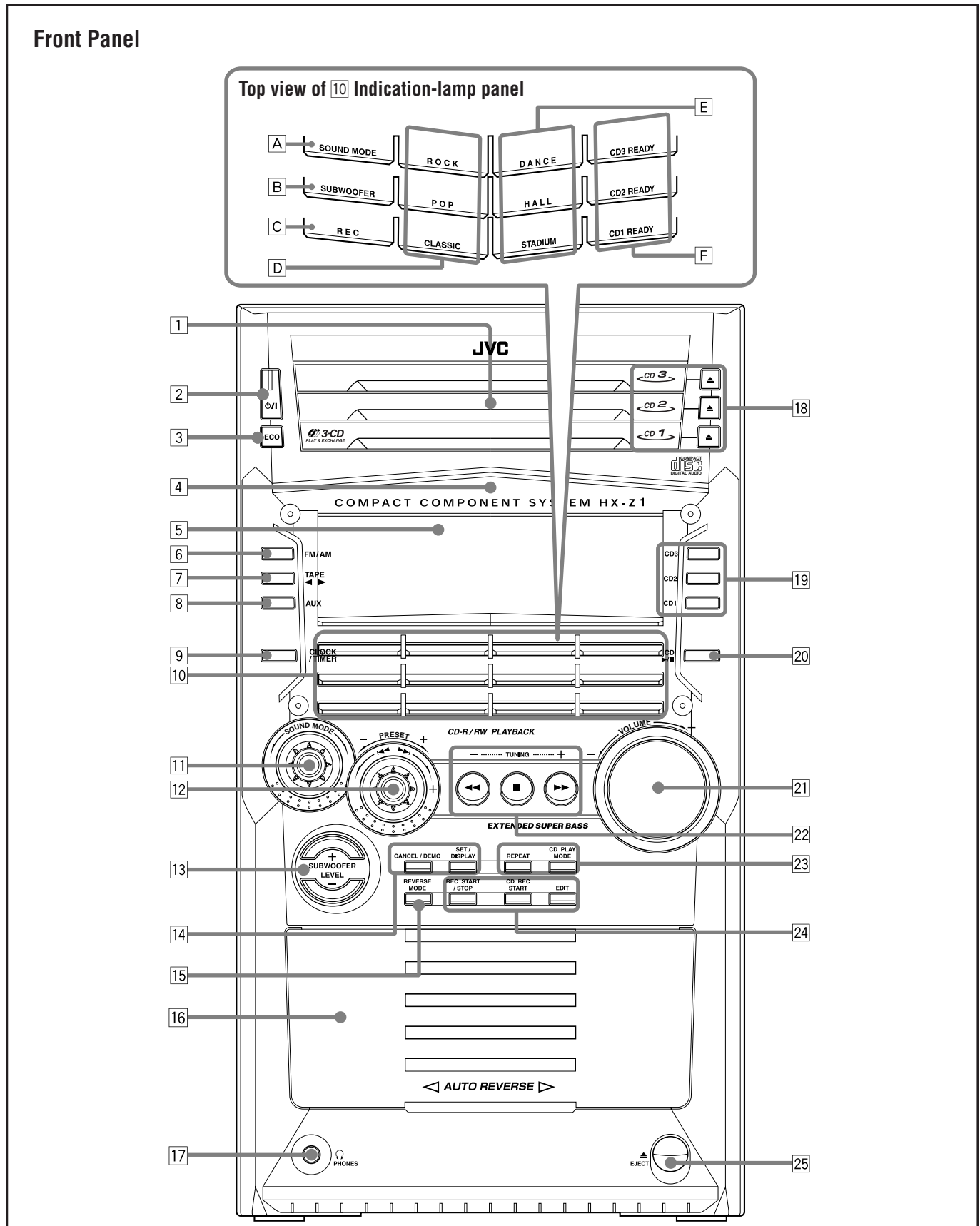

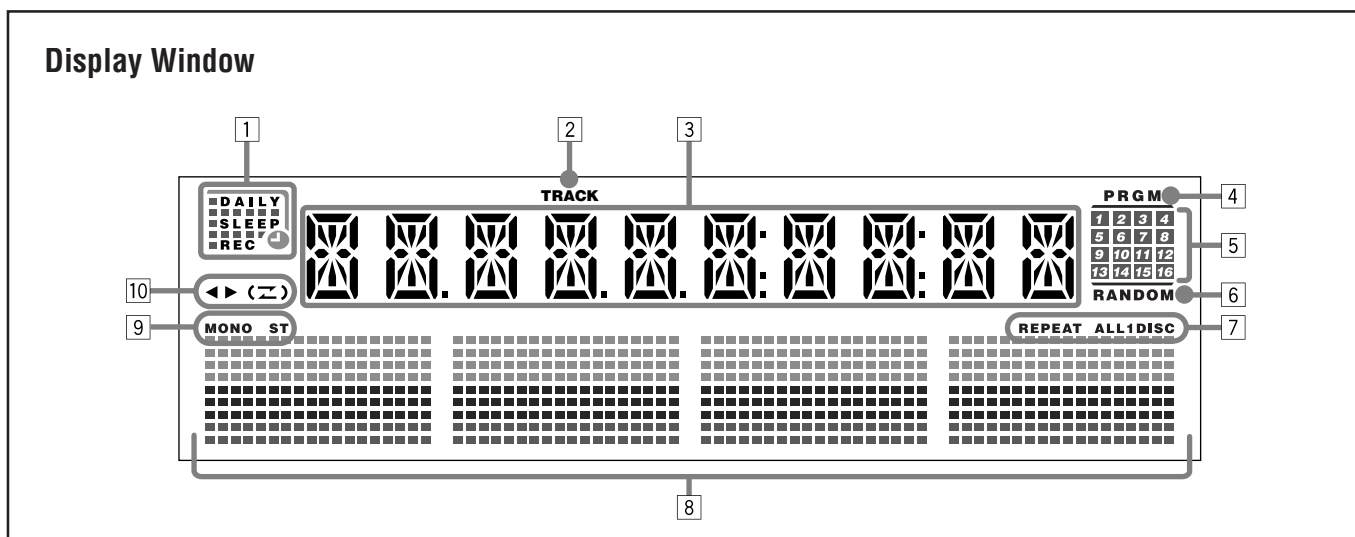

See pages in the parentheses for details.

Front Panel

- 1 Disc trays
- 2 O/I (standby/on) button and lamp (9, 23, 24)
- 3 ECO (Ecology) button (9)
- 4 Remote sensor
- 5 Display window
- 6 FM/AM button (10, 12)
Pressing this button also turns on the unit.
- 7 TAPE $\blacktriangleleft \blacktriangleright$ button (10, 18, 19)
Pressing this button also turns on the unit.
- 8 AUX button (10)
Pressing this button also turns on the unit.
- 9 CLOCK/TIMER button (9, 22 – 25)
- 10 Indication-lamp panel
 - A SOUND MODE lamp (10)
 - B SUBWOOFER lamp (10)
 - C REC (recording) lamp (19 – 21)
 - D SEA (Sound Effect Amplifier) mode lamps (10)
 - ROCK, POP, and CLASSIC lamps
 - E Surround mode lamps (10)
 - DANCE, HALL, and STADIUM lamps
 - F CD ready lamps (13)
 - CD1 READY, CD2 READY, and CD3 READY lamps
- 11 SOUND MODE control (10)
- 12 PRESET + / – control (12)
 $\blacktriangleleft \blacktriangleleft / \blacktriangleright \blacktriangleright$ (reverse skip/forward skip) control (9, 11, 14 – 16, 21 – 24)
- 13 SUBWOOFER LEVEL + / – buttons (10)
- 14 Setting buttons (8, 9, 11, 12, 15, 16, 21 – 25)
 - CANCEL/DEMO and SET/DISPLAY buttons
- 15 REVERSE MODE button (18 – 21)
- 16 Cassette holder (18 – 21)
- 17 PHONES (Q) jack (10)
- 18 \blacktriangle (Disc tray open/close) (CD1, CD2, and CD3) buttons (13, 14, 17)
Pressing one of these buttons also turns on the unit.
- 19 Disc number (CD1, CD2, and CD3) buttons (14, 15, 20, 21)
Pressing one of these buttons also turns on the unit.
- 20 CD $\blacktriangleright / \text{II}$ button (10, 14 – 16, 21)
Pressing this button also turns on the unit.
- 21 VOLUME + / – control (10)
- 22 TUNING + / – buttons (12)
 - $\blacktriangleleft \blacktriangleleft / \blacktriangleright \blacktriangleright$ (reverse search/forward search) buttons (11, 14, 18)
 - \blacksquare (stop) button (14 – 21, 24)
- 23 CD play mode buttons (15 – 17)
 - CD PLAY MODE and REPEAT buttons
- 24 Recording buttons (19 – 21, 24)
 - REC START/STOP, CD REC START, and EDIT buttons
- 25 \blacktriangle EJECT button for cassette deck (18 – 20)

Display Window

- 1 Timer indicators
 - DAILY (Daily Timer), SLEEP (Sleep Timer), REC (Recording Timer), and O (Timer) indicators
- 2 TRACK indicator
- 3 Main display
 - Shows the source name, frequency, etc.
- 4 PRGM (program) indicator
- 5 CD track number (1 – 16) indicators
- 6 RANDOM indicator
- 7 REPEAT (ALL/1/DISC) indicators
- 8 Audio level indicator
When one of the 6 preset sound modes is activated, these will function as display illumination. For details, see “Selecting the Sound Modes” on pages 10 and 11.
- 9 Tuner operation indicators
 - MONO and ST (stereo) indicators
- 10 Tape operation indicators
 - $\blacktriangleleft \blacktriangleright$ (tape direction) and Z (reverse mode) indicators



Remote Control

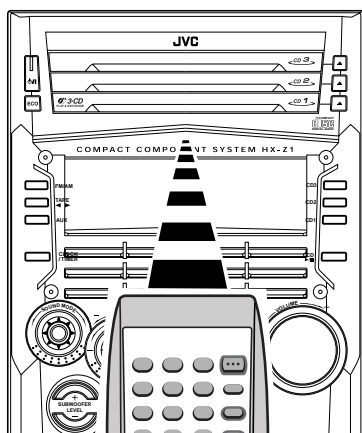
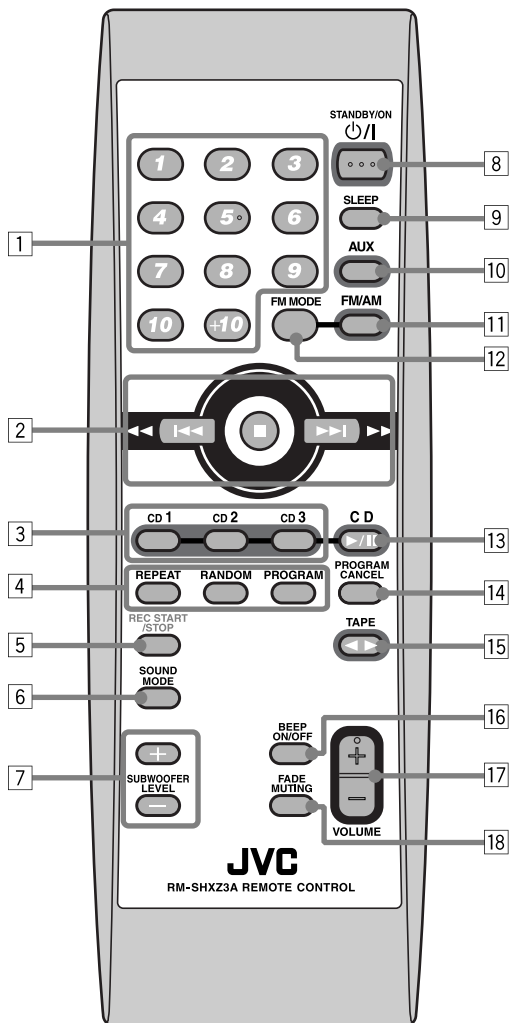

When using the remote control, point it at the remote sensor on the front panel.

Remote Control

- 1 Number buttons (12, 14, 15)
- 2 ◀◀ (◀◀) (reverse skip/reverse search) button (12, 14, 16, 18)
■ (stop) button (14 – 16, 18 – 21, 24)
▶▶ (▶▶) (forward skip/forward search) button (12, 14, 16, 18)
- 3 Disc number (CD1, CD2, and CD3) buttons (14, 15)
- 4 CD play mode buttons (15 – 17)
• REPEAT, RANDOM and PROGRAM buttons
- 5 REC START/STOP button (19, 21, 24)
- 6 SOUND MODE button (10)
- 7 SUBWOOFER LEVEL + / – buttons (10)
- 8 STANDBY/ON ◻/◻ button (9)
- 9 SLEEP button (25)
- 10 AUX button (10)
- 11 FM/AM button (10, 12)
- 12 FM MODE button (12)
- 13 CD ▶/◻ button (10, 14 – 16)
- 14 PROGRAM CANCEL button (16)
- 15 TAPE ◀▶ button (10, 18, 19)
- 16 BEEP ON/OFF button (8, 11)
- 17 VOLUME + / – button (10)
- 18 FADE MUTING button (10)

Supplied Accessories

Make sure that you have all the following items. The number in the parentheses indicates the quantity of the pieces supplied.

- AM loop antenna (1)
- FM antenna (1)
- Remote control (1)
- Batteries (2)

If anything is missing, consult your dealer immediately.

Putting the Batteries into the Remote Control

Insert the batteries—R6(SUM-3)/AA(15F)—into the remote control, by matching the polarity (+ and -) on the batteries with the + and - markings on the battery compartment. When the remote control can no longer operate the unit, replace both batteries at the same time.

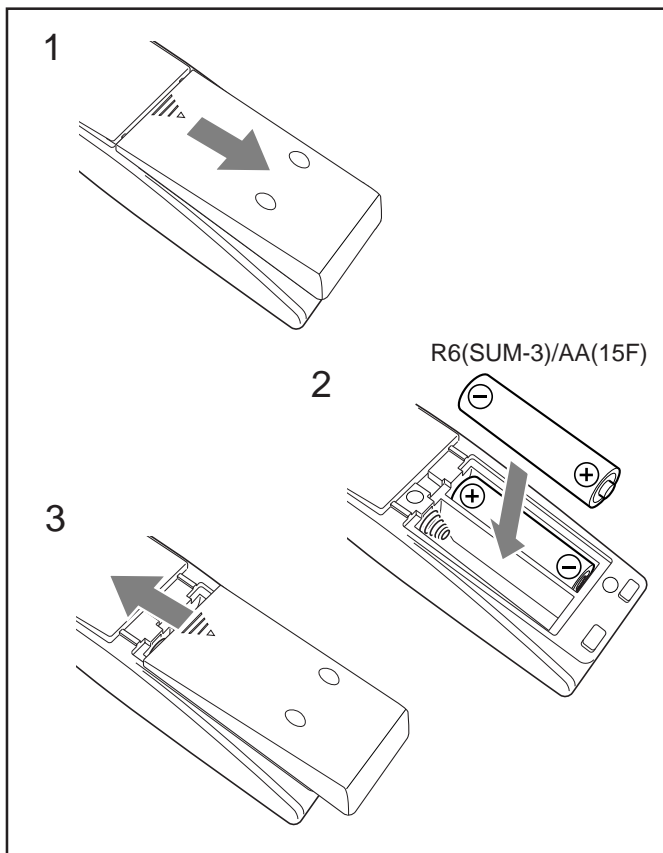

- DO NOT use an old battery together with a new one.
- DO NOT use different types of batteries together.
- DO NOT expose batteries to heat or flame.
- DO NOT leave the batteries in the battery compartment when you are not going to use the remote control for an extended period of time. Otherwise, it will be damaged from battery leakage.

Connecting Antennas

FM antenna

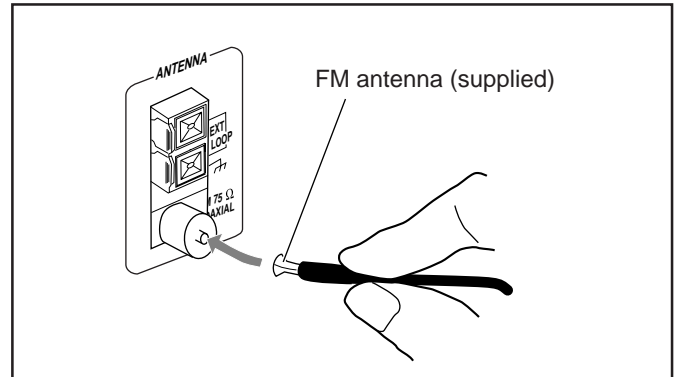

- 1 Attach the FM antenna to the FM 75 Ω COAXIAL terminal.
- 2 Extend the FM antenna.
- 3 Fasten it up in the position which gives you the best reception, then fix it on the wall, etc.



About the supplied FM antenna

The FM antenna supplied with this unit can be used as temporary measure. If reception is poor, you can connect an outdoor FM antenna.

To connect an outdoor FM antenna

Before connecting it, disconnect the supplied FM antenna.

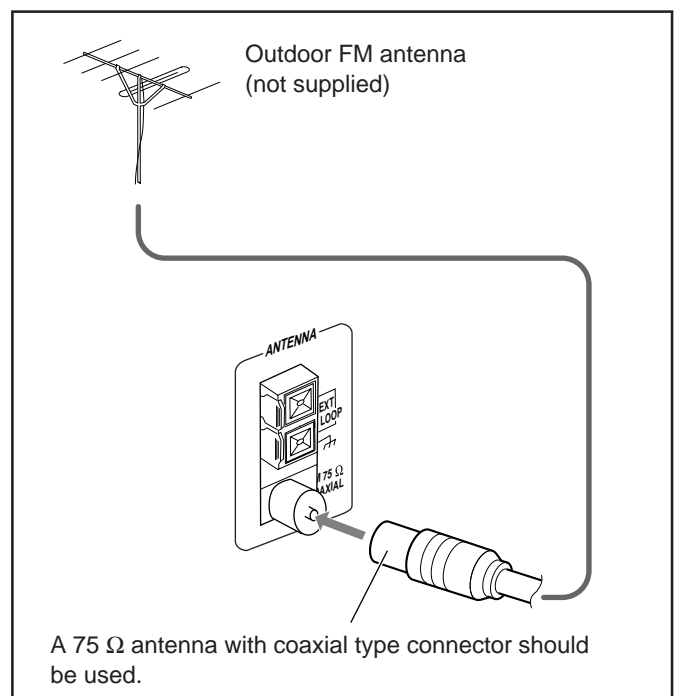

AM antenna

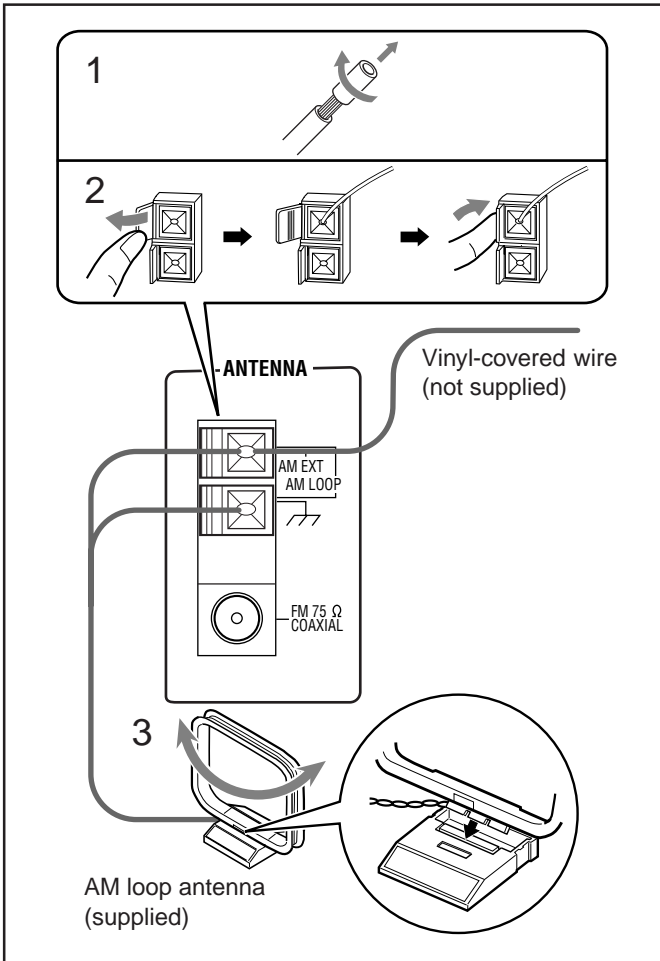

- 1 If cords are covered with insulation, twist the core of the cord at the end of each cord, then remove the insulation.
- 2 Connect the AM loop antenna to the AM LOOP terminals as illustrated.
- 3 Turn the AM loop antenna until you have the best reception.

To connect an outdoor AM antenna

When reception is poor, connect a single vinyl-covered wire to the AM EXT terminal and extend it horizontally. The AM loop antenna must remain connected.



For better reception of both FM and AM

- Make sure the antenna conductors do not touch any other terminals and connecting cords.
- Keep the antennas away from metallic parts of the unit, connecting cords, and the AC power cord.

Connecting Speakers

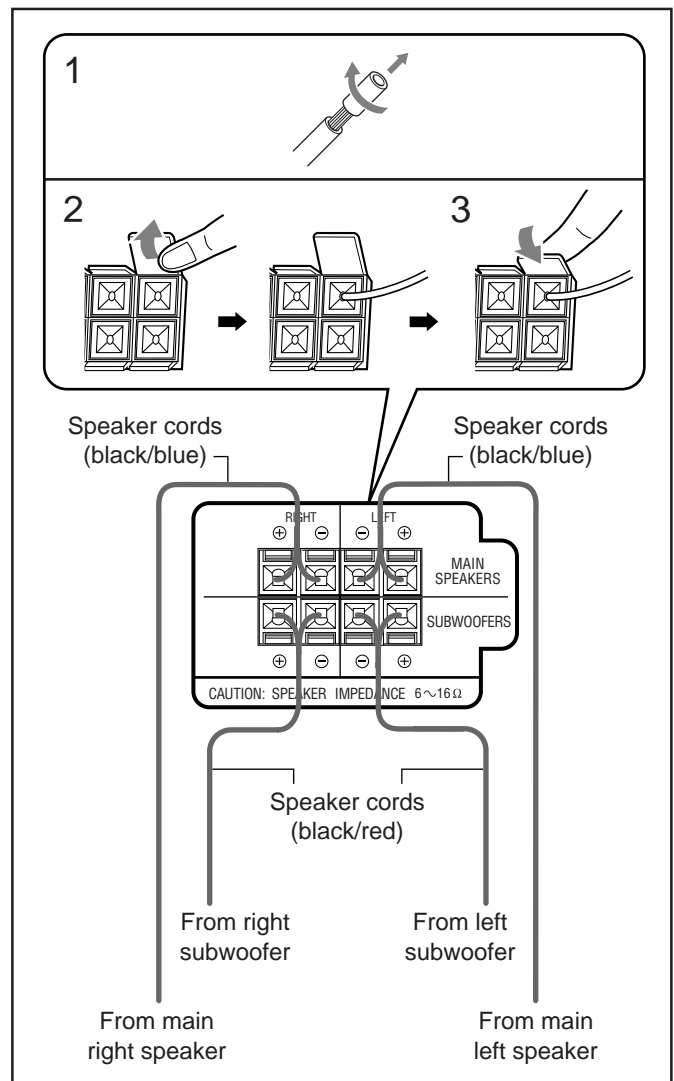

- 1 If cords are covered with insulation, twist the core of the cord at the end of each cord, then remove the insulation.
- 2 Insert the end of the speaker cord into the terminal as illustrated.
Match the same polarity: (+) to (+) and (-) to (-).
- 3 Close the speaker terminals.

IMPORTANT: Use only speakers with the same speaker impedance as indicated by the speaker terminals on the rear of the unit.



- DO NOT connect more than one speaker to each speaker terminal.
- DO NOT push or pull the speakers as this will damage the foot spacers at the bottom of the speakers.



Connecting Other Equipment

You can connect both analog and digital equipment.



- DO NOT connect any equipment while the power is on.
- DO NOT plug in any equipment until all connections are complete.

To connect an analog component

Be sure that the plugs of the audio cords are colored: White plugs and jacks are for left audio signals, and red ones for right audio signals.

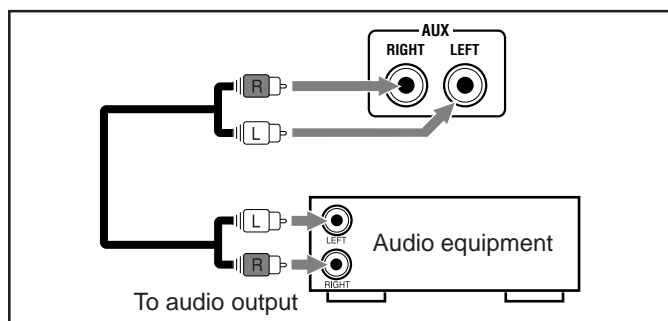

For playing the other equipment through this unit, connect between the audio output jacks on the other equipment and AUX jacks by using audio cords (not supplied).

To connect audio equipment with an optical digital input terminal

You can record CD sound onto the connected digital equipment.

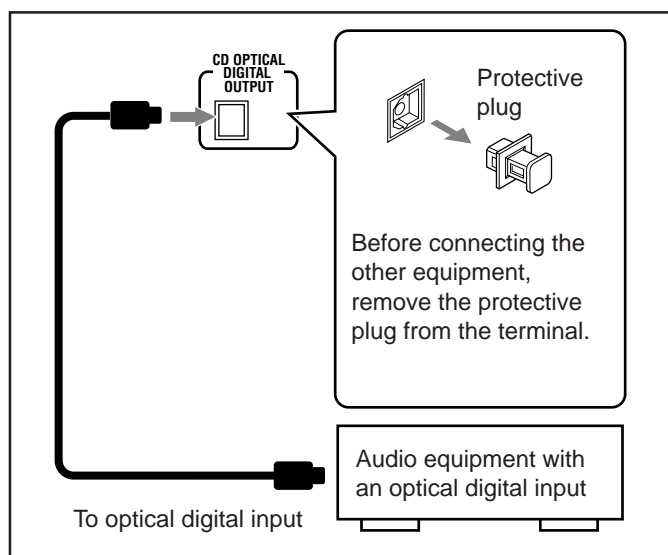

Connect an optical digital cord (not supplied) between the optical digital input terminal on the other equipment and the CD OPTICAL DIGITAL OUTPUT terminal.

Now, you can plug the AC power cord.

IMPORTANT: Be sure to check all connections to be done before plugging the AC power cord into a wall outlet.

Canceling the Demonstration

When connecting the AC power cord into a wall outlet, the unit automatically starts the demonstration.

To cancel the demonstration, press and hold CANCEL/DEMO until “DEMO OFF” appears on the display.



- To cancel only beep sounds during the demonstration, press BEEP ON/OFF on the remote control.



When you press other buttons



The demonstration stops temporarily. It will start automatically again (if no operation is done for 2 minutes) unless you cancel it by pressing CANCEL/DEMO.

To start the demonstration manually

Press and hold CANCEL/DEMO again until “DEMO START” appears on the display.



Common Operations

Turning On or Off the Power

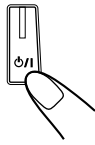
To turn on the unit, press  (or STANDBY/ON  on the remote control) so that the lamp on the button goes off.



POWER ON

To turn off the unit (on standby), press  (or STANDBY/ON  on the remote control) again so that the lamp on the button lights up.

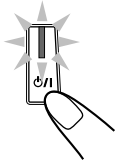

- A little power is always consumed even while the unit is on standby.

To switch off the power supply completely, unplug the AC power cord from the AC outlet.



When you unplug the AC power cord or if a power failure occurs

The clock is reset to “AM 12:00” right away, while the tuner preset stations (see page 12) will be erased in a few days.

Saving the Power Consumption while on Standby —Ecology Mode

You can save the power consumption while the unit is turned off (on standby).

- You can set Ecology Mode whether the unit is on or off.

On the unit ONLY:

To activate the Ecology Mode, press ECO. “ECO” appears on the display for 2 seconds (and demonstration is canceled temporarily if you have pressed the button while the unit is off).



- Each time you press the button, “ECO” and “NORMAL” appear alternately on the display.

To deactivate the Ecology Mode, press ECO again. “NORMAL” appears (and demonstration starts if the unit is turned off).



When you turn off the unit with Ecology Mode activated

“ECO” flashes on the display, and the clock time will not be shown while the unit is turned off.

Setting the Clock

You can set the clock whether the unit is on or off; however, if Ecology Mode is activated, you cannot set the clock while the unit is off. “AM 12:00” flashes on the display until you set the clock.

On the unit ONLY:

1 Press CLOCK/TIMER.

The hour digits start flashing on the display.

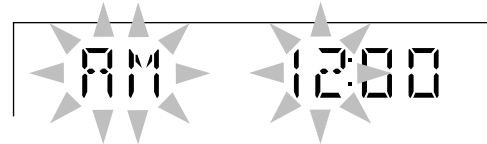
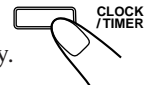

2 Turn / to adjust the hour, then press SET/DISPLAY.

The minute digits start flashing on the display.

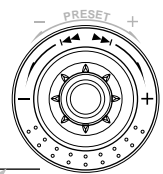

If you want to correct the hour after pressing SET/DISPLAY, press CANCEL/DEMO.

CANCEL / DEMO



The hour digits start flashing again.

SET / DISPLAY



3 Turn / to adjust the minute, then press SET/DISPLAY.

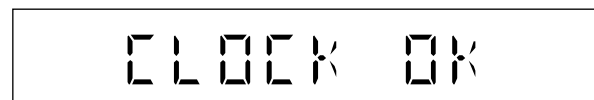

To check the clock time

Press and hold SET/DISPLAY while playing any source.

- Each time you press and hold the button, the source indication and the clock time alternate on the display.

To adjust the clock again

If you have set the clock before, you need to press CLOCK/TIMER repeatedly until the clock setting mode is selected.

- Each time you press the button, the clock/timer setting modes change as follows:

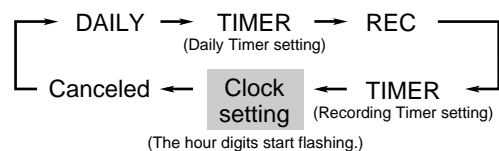

When you unplug the AC power cord or if a power failure occurs

The clock loses the setting and is reset to “AM 12:00.” You need to set the clock again.

Selecting the Sources

- To listen to the FM/AM broadcasts, press FM/AM. (See page 12.)
- To play back CDs, press CD ►/II. (See pages 13 – 17.)
- To play back tapes, press TAPE ◀▶. (See page 18.)
- To select the external equipment as the source, press AUX.

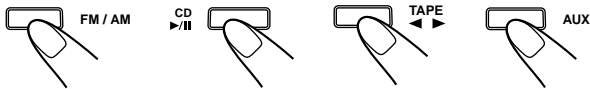

When you press the play button for a particular source (FM/AM, CD ►/II, TAPE ◀▶, and AUX), the unit turns on and the unit starts playing the source if it is ready.

Adjusting the Volume

You can adjust the volume level only while the unit is turned on. The volume level can be adjusted in 32 steps (VOLUME MIN, VOLUME 1 – VOLUME 30, and VOLUME MAX).

Turn **VOLUME + / –** clockwise (+) to increase the volume or counterclockwise (–) to decrease it.

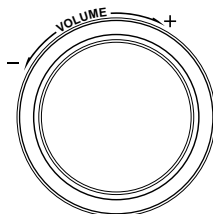

When using the remote control, press **VOLUME +** to increase the volume or **VOLUME –** to decrease it.



For private listening

Connect a pair of headphones to the PHONES (🎧) jack. No sound comes out of the speakers. Be sure to turn down the volume before connecting or putting on headphones.



DO NOT turn off (on standby) the unit with the volume set to an extremely high level; otherwise, a sudden blast of sound can damage your hearing, speakers and/or headphones when you turn on the unit or start playing any source next time. REMEMBER you cannot adjust the volume level while the unit is on standby.

To turn down the volume level temporarily

On the remote control ONLY:

Press FADE MUTING.

The volume level gradually decreases to “VOLUME MIN.”



To restore the sound, press the button again.

Reinforcing the Bass Sound

You can select one of the 5 subwoofer levels. This function only affects the playback sound, but does not affect your recording. The subwoofer level can be adjusted in 5 steps—LEVEL 0 (MIN LEVEL), LEVEL 1, LEVEL 2, LEVEL 3, and LEVEL 4 (MAX LEVEL).

Press **SUBWOOFER LEVEL +** to increase the subwoofer level or **SUBWOOFER LEVEL –** to decrease it.



SUBWOOFER lamp lights up in red

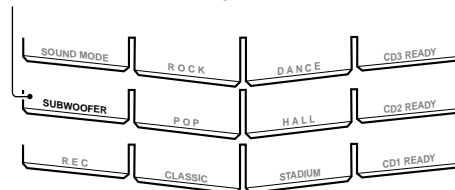

- The SUBWOOFER lamp lights up in red when LEVEL 1 to LEVEL 4 (MAX LEVEL) is selected. The lamp lights off when LEVEL 0 (MIN LEVEL) is selected.

Selecting the Sound Modes

You can select one of the 6 preset sound modes (3 surround modes and 3 SEA—Sound Effect Amplifier—modes) and 3 user modes. This function only affects the playback sound, but does not affect your recording. Each Sound Mode has its own display illumination.

To select the sound modes, turn **SOUND MODE** (or press **SOUND MODE** on the remote control) until the sound mode you want appears on the display.

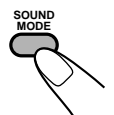
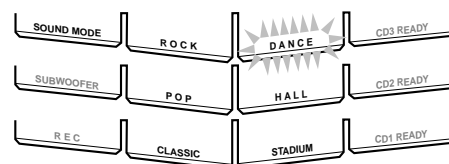
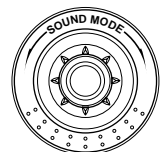

- When a sound mode is selected (for this example DANCE), the SOUND MODE lamp and other than the selected sound mode lamps light up. While the selected sound mode lamp flashes. (If USER 1, USER 2, and USER 3 is selected, only the SOUND MODE lamp lights up. If OFF is selected, the SOUND MODE lamp and other sound mode lamps go off.)

The sound modes change as follows:

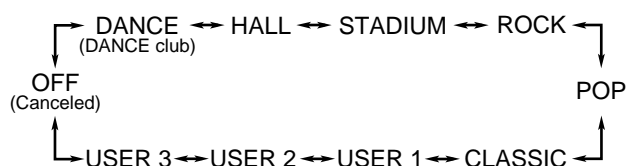

When using the remote control, the sound mode changes clockwise in the above sequence.

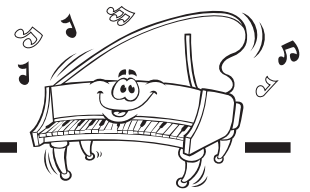

Surround modes*

- DANCE:** Increases resonance and bass.
HALL: Adds depth and brilliance to the sound.
STADIUM: Adds clarity and spreads the sound, like in an outdoor stadium.

SEA (Sound Effect Amplifier) modes

- ROCK:** Boosts low and high frequency. Good for acoustic music.
POP: Good for vocal music.
CLASSIC: Good for classical music.

User Modes

USER 1/2/3: Your individual mode stored in memory. See “Creating Your Own Sound Mode—User Mode” below.

OFF: The sound mode is canceled.

* Surround elements are added to the SEA elements to create a being-there feeling in your room.

Creating Your Own Sound Mode—User Mode

You can change SEA pattern to suit your preference. The SEA pattern can be adjusted into 5 frequency range—LOW1, LOW2, MID, HIGH1, and HIGH2. These changed settings can be stored in the USER 1, USER 2, and USER 3 modes.

- There is a time limit in doing the following steps. If the setting is canceled before you finish, start from step 1 again.

On the unit ONLY:

1 Select one of the preset sound modes.

- If you want to add the surround elements in your SEA pattern, select one of the surround modes (DANCE, HALL, or STADIUM) before starting the procedure below. (See “Selecting the Sound Modes” on page 10.)

2 Press SET/DISPLAY while the selected sound mode is still shown on the display.

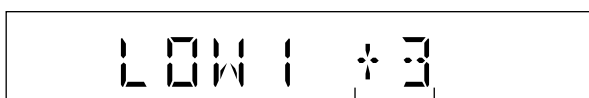
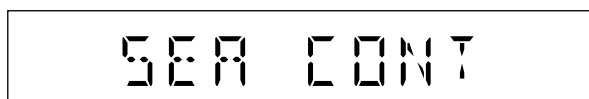
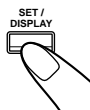

Current level appears.

3 Adjust the SEA pattern.

- 1) Turn |◀◀ / ▶▶| to select the frequency range (LOW1, LOW2, MID, HIGH1, and HIGH2).

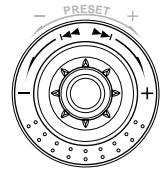

- 2) Press ◀◀ or ▶▶ to adjust the level (-3 to +3) of the selected frequency range.

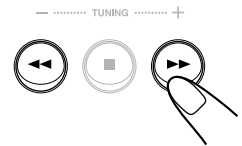

- 3) Repeat steps 1) and 2) to adjust the level of the other frequency ranges.

4 Press SET/DISPLAY again.

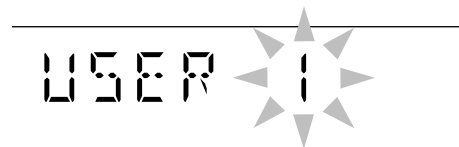
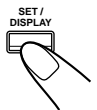

5 Turn |◀◀ / ▶▶| to select one of the user modes (USER 1, USER 2, and USER 3) which you want to store the SEA pattern.

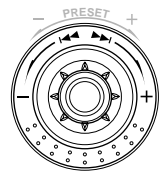

6 Press SET/DISPLAY again.

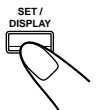

The SEA pattern you have created are stored into the user mode selected in the above step.

To use your own sound mode

Select USER 1, USER 2, or USER 3 mode when using the sound modes. See “Selecting the Sound Modes” on page 10.



When you unplug the AC power cord or if a power failure occurs

The setting will be erased in a few days. If this happens, set the user modes again.

Turning On or Off the Key-touch Tone

If you do not want the key-touch tone to beep each time you press a button, you can deactivate it.

On the remote control ONLY:

Press BEEP ON/OFF.

- Each time you press the button, the key-touch tone turns on and off alternately.





Listening to FM and AM Broadcasts

Tuning in to a Station

1 Press FM/AM.

The unit automatically turns on and tunes in to the previously tuned station (either FM or AM).

- Each time you press the button, the band alternates between FM and AM.

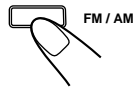

2 Start searching for stations.

On the unit:

Press and hold TUNING + or TUNING – for more than 1 second.

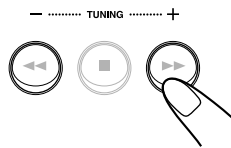

On the remote control:

Press and hold >>> (right arrow) or <<< (left arrow) for more than 1 second.

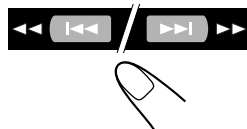

The unit starts searching for stations and stops when a station of sufficient signal strength is tuned in.

- If a program is broadcast in stereo, the ST (stereo) indicator lights up.

To stop searching, press TUNING + or TUNING – (or >>> / <<< on the remote control).



When you press TUNING + or TUNING – (or >>> / <<< on the remote control) briefly and repeatedly the frequency changes step by step.

To change the FM reception mode

On the remote control ONLY:

When an FM stereo broadcast is hard to receive or noisy, press FM MODE so that the MONO indicator lights up on the display. Reception improves.



To restore the stereo effect, press FM MODE again so that the MONO indicator goes off. In this stereo mode, you can hear stereo sounds when a program is broadcasted.

Presetting Stations

You can preset 30 FM and 15 AM stations.

In some cases, test frequencies have been already memorized for the tuner since the factory examined the tuner preset function before shipment. This is not a malfunction. You can preset the stations you want into memory by following the presetting method.

- There is a time limit in doing the following steps. If the setting is canceled before you finish, start from step 2 again.

On the unit ONLY:

1 Tune in to the station you want to preset.

- See “Tuning in to a Station.”

2 Press SET/DISPLAY.

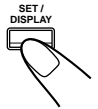
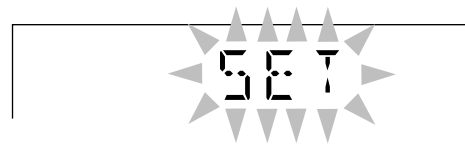

3 Turn PRESET + / – to select a preset number.

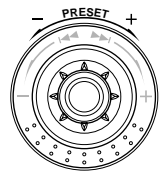
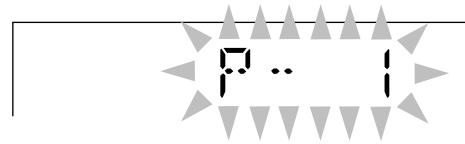

4 Press SET/DISPLAY again.

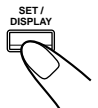
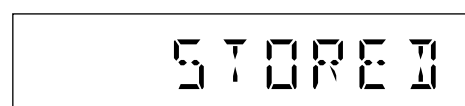

The tuned station in step 1 is stored in the preset number selected in step 3.

- Storing a new station on a used number erases the previously stored one.



When you unplug the AC power cord or if a power failure occurs

The preset stations will be erased in a few days. If this happens, preset the stations again.

Tuning in to a Preset Station

1 Press FM/AM.

The unit automatically turns on and tunes in to the previously tuned station (either FM or AM).

- Each time you press the button, the band alternates between FM and AM.



2 Select a preset number.

On the unit:

Turn PRESET + / –.

On the remote control:

Press the number buttons.

Ex.: For preset number 5, press 5.

For preset number 15, press +10, then 5.

For preset number 25, press +10, +10, then 5.

For preset number 30, press +10, +10, then 10.

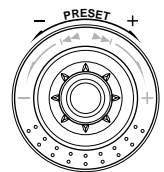
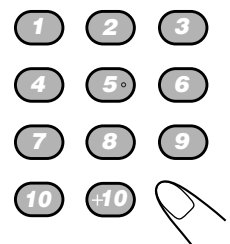

Playing Back CDs (CD/CD-R/CD-RW)

This unit has been designed to playback the following CDs:

- CD (Audio CD)
- CD-R (CD-Recordable)
- CD-RW (CD-ReWritable)

Continued use of irregular shape CDs (heart-shape, octagonal, etc.) can damage the unit.

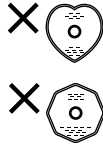

When playing a CD-R or CD-RW

User-edited CD-Rs (CD-Recordable) and CD-RWs (CD-ReWritable) can be played back only if they are already “finalized.”

- You can play back your original CD-Rs or CD-RWs recorded in music CD format. (However, they may not be played back depending on their characteristics or recording conditions.)
- Before playing back CD-Rs or CD-RWs, read their instructions or cautions carefully.
- Some CD-Rs or CD-RWs may not be played back on this unit because of their disc characteristics, damage or stain on them, or the player’s lens is dirty.
- CD-RWs may require a longer readout time. This is caused by the fact that the reflectance of CD-RWs is lower than for regular CDs.

Loading CDs

On the unit ONLY:

- 1 Press  for the disc tray (CD1, CD2, and CD3) you want to load a CD onto.**

The unit automatically turns on and the disc tray comes out.

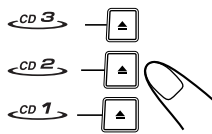

- 2 Place a disc correctly on the circle of the disc tray, with its label side up.**

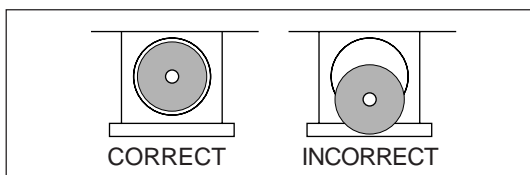

- When using a CD single (8 cm), place it on the inner circle of the disc tray.

- 3 Press the same  you have pressed in step 1.**

The disc tray closes.



- 4 Repeat steps 1 to 3 to place other CDs.**



When loading more than one CD continuously

When you press  for the next tray you want to place another CD onto, the first disc tray automatically closes and then the next tray comes out.

About the CD ready lamps

Each CD ready lamp corresponds to the disc tray of the same number.

• When and why they light up?

- When you turn on the unit for the first time after plugging into a wall outlet, all CD ready lamps (CD1 READY, CD2 READY, and CD3 READY) lights up. From the next time on, CD ready lamp(s) light(s) up according to the previous condition.
- Each time you press the CD eject buttons— (CD1, CD2, and CD3), the corresponding CD ready lamp lights up.

• When and why they go off?

- Only when the unit detects there is no CD loaded on the tray, the corresponding CD ready lamp goes off. (“NO DISC 1,” “NO DISC 2,” or “NO DISC 3” appears on the display.)

• When and why they flash?

- The corresponding CD ready lamp flashes during playback and pause.

Playing Back the Entire Discs—Continuous Play

You can play CDs continuously.

1 Load CDs.

2 Press one of the disc number (CD1, CD2, and CD3) buttons for the disc you want to play.

The unit starts searching for the CD and CD play starts from the first track of the selected disc.

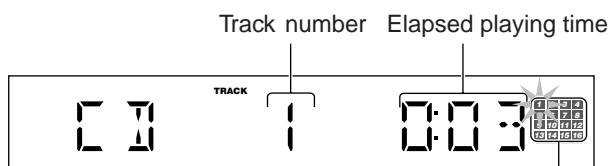
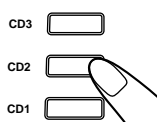

Tracks of the currently playing disc (Track numbers exceeding 16 are not displayed.)

- Pressing CD ►/|| instead of the disc number buttons starts playing back the currently selected CD.
- If no CD is placed on the selected disc tray, “NO DISC 1,” “NO DISC 2,” or “NO DISC 3” appears on the display. Then, the unit continue searching for a CD from the next disc tray.

To stop playing, press ■.

To remove the disc, press ▲ for the corresponding disc tray.



CD playback sequence

When 3 CDs* are loaded on the disc trays, they are played in one of the following sequences.

- When CD1 is pressed: CD1 ⇒ CD2 ⇒ CD3 (then stops)
- When CD2 is pressed: CD2 ⇒ CD3 ⇒ CD1 (then stops)
- When CD3 is pressed: CD3 ⇒ CD1 ⇒ CD2 (then stops)

* When only 2 CDs are loaded, they are played in the same order, but the disc tray without a CD is skipped.

Basic CD Operations

While playing a CD, you can do the following operations.

To exchange CDs during playback of another

Press ▲ corresponding to a CD, not playing or selected currently, to eject and exchange the CD.

If you exchange CDs during play, the current play will not stop until all CDs you have exchanged are played.

To stop play for a moment

Press CD ►/||.

While pausing, the elapsed playing time flashes on the display.

To resume playing, press CD ►/|| again.



To go to another track

Turn ◀◀◀ / ▶▶▶ before or during playback (or press ◀◀◀ (◀◀◀) / ▶▶▶ (▶▶▶) on the remote control).

- ◀◀◀ (or ◀◀◀ (◀◀◀)): Goes back to the beginning of the current or previous tracks.
- ▶▶▶ (or ▶▶▶ (▶▶▶)): Skips to the beginning of the next or succeeding tracks.

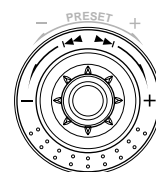

To locate a particular point in a track

During play, press and hold ◀◀ or ▶▶ (or ◀◀◀ (◀◀◀) / ▶▶▶ (▶▶▶) on the remote control).

- ◀◀ (or ◀◀◀ (◀◀◀)): Fast reverses the disc.
- ▶▶ (or ▶▶▶ (▶▶▶)): Fast forwards the disc.

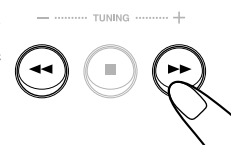

To go to another track directly using the number buttons

On the remote control ONLY:

Pressing the number button(s) before or during play allows you to start playing the track number you want.

Ex.: For track number 5, press 5.

For track number 15, press +10, then 5.

For track number 20, press +10, then 10.

For track number 32, press +10, +10, +10, then 2.

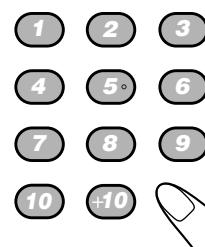

Programming the Playing Order of the Tracks —Program Play

You can arrange the playing order of the tracks before you start playing. **You can program up to 32 tracks.**

- To use Repeat Play (see page 17) for Program Play, press REPEAT after starting Program Play. Only REPEAT 1 and REPEAT ALL can be selected for Program Play.
- There is a time limit in doing the following steps. If the setting is canceled before you finish, start from step 2 again.

1 Load CDs.

- If the current playing source is not the CD player, press CD ►/II, then ■ before going to the next step.

2 Activating the Program Play mode.

On the unit:

Press CD PLAY MODE repeatedly until “CD PROGRAM” appears on the display.



- Each time you press the button, the play mode changes as follows:

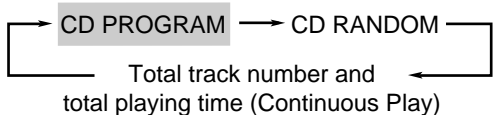

On the remote control:

Press PROGRAM so that “CD PROGRAM” appears on the display.



- If a program has been stored in memory, the program is called up.
- The PRGM (program) indicator also lights up on the display.

3 Press one of the disc number (CD1, CD2, and CD3) buttons to select the disc you want to play.

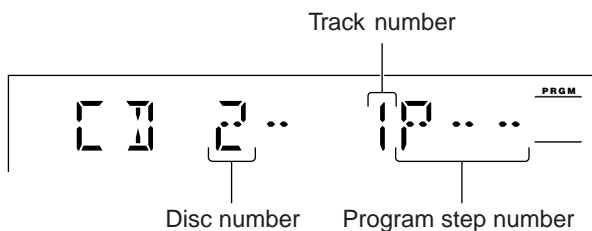
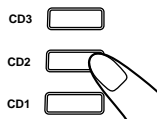

4 Select a track from the selected CD in the above step.

On the unit:

Turn |◀◀ / ▶▶| to select the track number and press SET/DISPLAY.

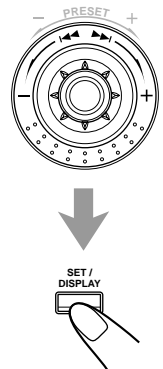

On the remote control:

Press the number buttons.

- For how to use the number buttons, see “To go to another track directly using the number buttons” on page 14.

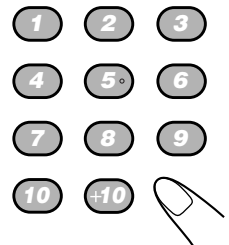

5 Program other tracks you want.

- To program tracks from the same disc, repeat step 4.
- To program tracks from a different disc, repeat steps 3 and 4.

6 Press CD ►/II.

The tracks are played in the order you have programmed.



To stop playing, press ■.

To exit from Program Play mode, press CD PLAY MODE repeatedly (or PROGRAM on the remote control) until the PRGM (program) indicator goes off. The program you have made is stored in memory.



- If you try to program a 33rd track “CD FULL” will appear on the display.

• If your entry is ignored

You have tried to program a track from an empty tray, or a track number that does not exist on the CD (for example, selecting track 14 on a CD that only has 12 tracks). Such entries are ignored.

To check the program contents

On the remote control ONLY:

Before playing, you can check the program contents by pressing

◀◀ (◀◀) or ▶▶ (▶▶).

- ◀◀ (◀◀) : Shows the programmed tracks in the reverse order.
- ▶▶ (▶▶) : Shows them in the programmed order.

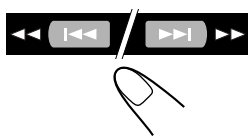

To modify the program

Before or after playing, you can erase the last programmed tracks by pressing CANCEL/DEMO (or press PROGRAM CANCEL on the remote control).

- Each time you press the button, the last programmed track is erased from the program.

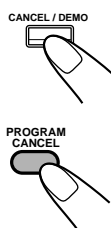

To add tracks in the program before playing, simply select the track numbers you want to add by following step 4 of the programming procedure on page 15. If you want to add tracks from another disc, follow steps 3 and 4.

To erase the entire program before or after playing, press and hold ■ until “CD PROGRAM” appears on the display.

- The program you have made will be erased,
 - when you unplug the AC power cord, and
 - when a power failure occurs.

Playing at Random—Random Play

The tracks of all loaded CDs will be played at random.

- To use Repeat Play (see page 17) for Random Play, press REPEAT after starting Random Play. Only REPEAT 1 and REPEAT ALL can be selected for Random Play.

1 Load CDs.

- If the current playing source is not the CD player, press CD ▶/||, then ■ before going to the next step.

2 Activating the Random Play mode.

On the unit:

Press CD PLAY MODE repeatedly until “CD RANDOM” appears on the display.

- Each time you press the button, the play mode changes as follows:

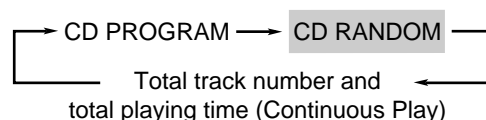

On the remote control:

Press RANDOM so that “CD RANDOM” appears on the display.

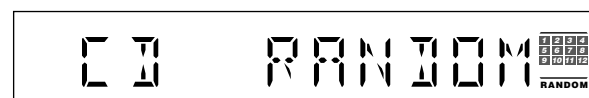

- The RANDOM indicator also lights up on the display.

3 Press CD ▶/||.

The tracks are randomly played. Random Play ends when all the tracks are played once.

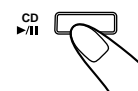

To skip the currently playing track, turn ◀◀ / ▶▶ to the right (or press ▶▶ (▶▶) on the remote control).



If you turn ◀◀ / ▶▶ to the left (or press ◀◀ (◀◀) on the remote control)

- You cannot go back to the previous tracks during Random Play.
- You can only restart the current playing track.

To stop playing, press ■.

- Random play also stops when one of the disc trays is opened.

To exit from Random Play mode, press CD PLAY MODE (or RANDOM on the remote control) repeatedly, until the RANDOM indicator goes off after playback stops.



Repeating Tracks or CDs—Repeat Play

You can have all the CDs, the program or the individual track currently playing to repeat as many times as you like.

To repeat playing, press REPEAT during or before play.

- Each time you press the button, Repeat Play mode changes as follows:

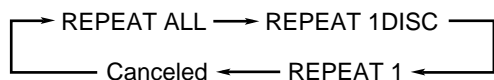

The Repeat Play mode indicator lights up on the display.

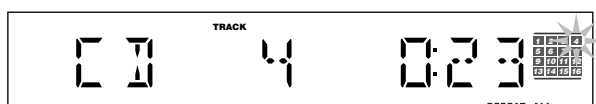

REPEAT ALL: Repeats all the tracks on all the CDs (continuously or at random), or all the tracks in the program.

REPEAT 1DISC: Repeats all the tracks on one CD.

REPEAT 1: Repeats one track on one CD.

To cancel Repeat Play, press REPEAT repeatedly until the Repeat Play mode indicators go off from the display.



“REPEAT 1DISC” is not selected for Program Play and Random Play

It is canceled when you select Program Play or Random Play.

Prohibiting Disc Ejection—Tray Lock

You can prohibit CD ejection from the unit and lock CDs.

- This operation is possible only when the source is the CD player.

On the unit ONLY:

To prohibit disc ejection, press ▲ for any disc tray while holding down ■. (If there is any disc tray opened, close it first.)

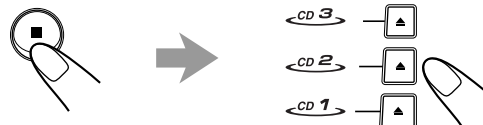

“LOCKED” appears for a while on the display, and the loaded CDs are locked.

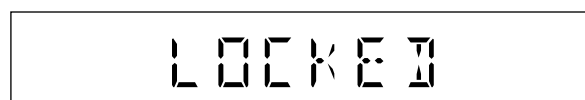

To cancel the prohibition and unlock the CDs, press ▲ for any disc tray while holding down ■.

“UNLOCKED” appears for a while on the display, and the loaded CDs are unlocked.

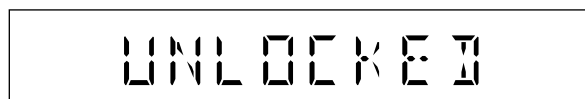

If you try to eject CDs while Tray Lock is in used “LOCKED” appears to inform you that the disc tray is locked.

Playing Back Tapes



You can play back type I tapes without changing any settings.

Playing Back a Tape

1 Press **EJECT** for the cassette deck.

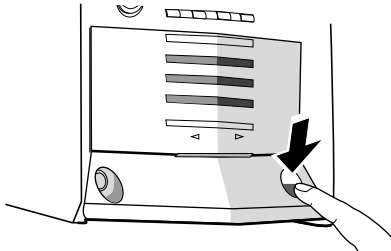

2 Put a cassette in with the exposed part of the tape down.

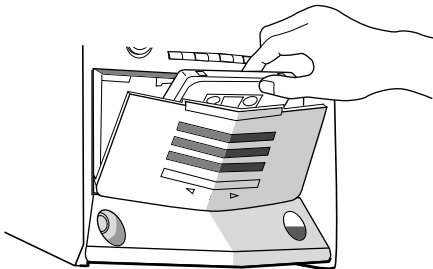

3 Close the cassette holder gently.

4 Press **TAPE** .

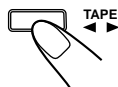

The tape play starts and the tape direction indicator (or) starts flashing slowly to indicate the tape running direction.

- Each time you press the button, the tape direction changes and “REVERSE” appears for a while on the display.
 - ▶ : plays the front side.
 - ◀ : plays the reverse side.

- If no cassette is inserted, “NO TAPE” appears on the display.

When the tape plays to the end, the deck automatically stops if the Reverse Mode is off. (See “To play both sides repeatedly—Reverse Mode.”)

To stop playing, press .

To fast-wind to the left or to the right, press (or) on the remote control) while the tape is not running.

The tape direction indicator (or) starts flashing quickly on the display.

To remove the cassette, press **EJECT** to open the cassette holder.



The use of the C-120 or thinner tape is not recommended, since characteristic deterioration may occur and this tape easily jams in the pinch-rollers and the capstans.

To play both sides repeatedly—Reverse Mode

When using Reverse Mode, the tape automatically reverses at the end of a side and the unit starts playing for the other side of the tape, and repeats the same process.

On the unit ONLY:

To use Reverse Mode, press REVERSE MODE so that the Reverse Mode indicator on the display lights up like—.

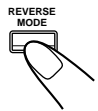

To cancel Reverse Mode, press the button again so that the Reverse Mode indicator on the display lights up like—.

Locating the Beginning of a Song—Music Scan

You can use Music Scan to locate the beginning of a song. Music Scan searches for blank portions that usually separate recorded songs, then plays the next song.

To find the beginning of the current song

During play, press or (or / on the remote control) in the **opposite direction** to the tape play.

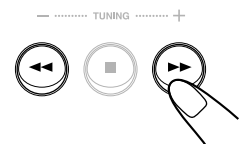

The tape direction indicator of the opposite direction to the tape play starts flashing intermittently.

Searching stops automatically at the beginning of the current song, and the current song starts automatically.

To find the beginning of the next song

During play, press or (or / on the remote control) in the **same direction** as the tape play.

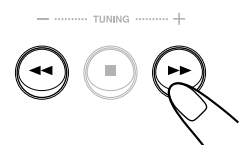

The tape direction indicator of the same direction as the tape play starts flashing intermittently.

Searching stops automatically at the beginning of the next song, and the next song starts automatically.



Music Scan works by detecting a 4-second long blank between each song, so it will not work well in the following cases

- No blank at the beginning of a song.
- Noise (often caused by much use or poor quality dubbing) which fills the blank.
- Long, very soft passages or pauses in a song.

Recording

IMPORTANT:

- It should be noted that it may be unlawful to re-record pre-recorded tapes, records, or discs without the consent of the owner of copyright in the sound or video recording, broadcast or cable programme and in any literary, dramatic, musical, or artistic embodied therein.
- The recording level is automatically set correctly, so it is not affected by the VOLUME, the SUBWOOFER LEVEL, and the SOUND MODE controls. Thus, during recording you can adjust the sound you are actually listening to without affecting the recording level.
- If there are excessive noise or static in the recording you have made, the unit may be too close to a TV. Increase the distance between the TV and the unit.
- You can use type I tape for recording.

To protect your recording

Cassettes have two small tabs on the back to protect from unexpected erasure or re-recording.

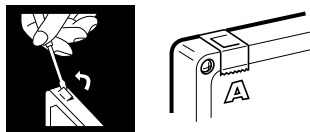

To protect your recording, remove these tabs.

To re-record on a protected tape, cover the holes with adhesive tape.

To keep the best recording and playback sound quality

If the heads, capstans, and pinch rollers of the cassette deck become dirty, the following will occur:

- Impaired sound quality
- Discontinuous sound
- Fading
- Incomplete erasure
- Difficulty in recording

To clean the heads, capstans, and pinch rollers

Use a cotton swab moistened with alcohol.

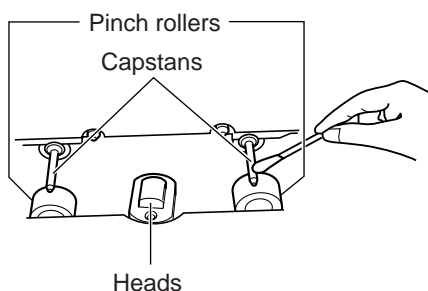

To demagnetize the heads

Turn off the unit, and use a head demagnetizer (available at electronics and audio shops).

Recording on a Tape

- 1 Press **▲ EJECT** to insert a recordable cassette with the exposed part of the tape down.

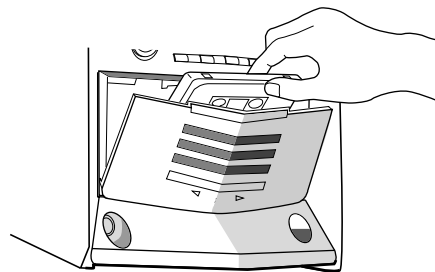

- 2 Close the cassette holder gently.
 - If you want to record on both sides of a tape, see “To record on both sides—Reverse Mode.”
- 3 Check the tape direction of the cassette deck.
 - If the tape direction is not correct, press TAPE **◀▶** twice then **■** to change the tape direction.
- 4 Start playing the source—FM, AM, CD player, or auxiliary equipment connected to AUX jacks.
 - When the source is CD, you can also use CD Direct Recording—(see page 20), and Auto Edit Recording—(see page 21).

- 5 Start recording.

On the unit:

Press **REC START/STOP**.

On the remote control:

Press and hold **REC START/STOP** for more than 1 second.

The REC (recording) lamp flashes when recording starts and the tape direction indicator (**▶** or **◀**) starts flashing slowly.

- If no cassette is inserted, “NO TAPE” appears on the display. If a protected tape is inserted, “NO REC” appears on the display.

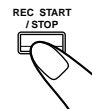

To stop recording immediately, press **REC START/STOP** or **■** (or press and hold **REC START/STOP** on the remote control for more than 1 second).

To remove the cassette, press **▲ EJECT** to open the cassette holder.

To record on both sides—Reverse Mode

On the unit ONLY:

Press **REVERSE MODE** so that the Reverse Mode indicator on the display lights up like—**⌂**.

- When using the Reverse Mode for recording, start recording in the forward (**▶**) direction first. Otherwise, recording will stop when recording is done only on one side (reverse) of the tape.

To cancel Reverse Mode, press the button again so that the Reverse Mode indicator on the display lights up like—**⌂**.

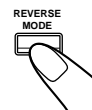

CD Synchronized Recording

By using CD Synchronized Recording methods, you can start and stop a CD play and tape recording at the same time.

CD Synchronized Recording consists of the followings:

- CD Direct Recording
- Auto Edit Recording

■ CD Direct Recording

Everything on the CD goes onto the tape in the order it is on the CD, or according to the order you have made for Program Play.

On the unit ONLY:

- 1** Press  **EJECT** to insert a recordable cassette in with the expose part of the tape down.



- 2** Load CDs.

- 3** Press one of the disc number (CD1, CD2, and CD3) buttons to select the disc, then .

- If you want to make a program, perform steps **2** to **5** on page 15. After making a program, go to the next step.

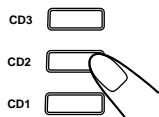

- 4** Press **CD REC START**.

“CD REC” appears on the display and the REC (recording) lamp flashes when recording starts.

The cassette deck starts recording while the CD player starts playing.

When the recording is done, “CD REC FINISHED” scroll through the display, and the REC (recording) lamp goes off. Both the cassette deck and the CD player stop automatically.



To stop recording, press  to create a 4-second blank portion on the recording tape. (Remember a 4-second blank is important when using Music Scan—see page 18.)





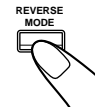

To record on both sides—Reverse Mode

On the unit ONLY:

Press REVERSE MODE so that the Reverse Mode indicator on the display lights up like—.



- When using the Reverse Mode for CD Direct Recording, start recording in the forward () direction first. When the tape reaches its end while recording a song in the forward direction () , the last song will be re-recorded at the beginning of the reverse side () . If you start recording on the reverse side () , recording will stop when recording is done only on one side (reverse) of the tape.

To cancel Reverse Mode, press the button again so that the Reverse Mode indicator on the display lights up like—.



■ Auto Edit Recording

By using Auto Edit Recording, you can record the CD tracks to fit the tape. Auto Edit Recording makes a program by selecting the CD tracks in numerical order. However, to prevent the end of the last track on the front side from being cut off, the last track is selected so to fit the remaining tape length.

On the unit ONLY:

1 Load CDs.

- If the current playing source is not the CD player, press CD ►/||, then ■ before going to the next step.

2 Press EDIT.



3 Press one of the disc number (CD1, CD2, and CD3) buttons to select the disc you want to record from.

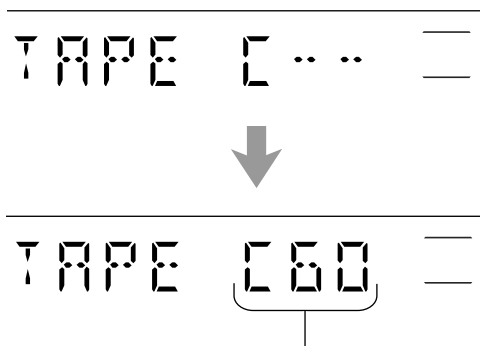
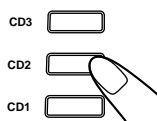

The optimum tape length for the disc appears.

To change the tape length manually

If the tape length selected is not satisfactory, you can change the tape length by turning |◀◀/▶▶| on the unit. You can select the tape length among the following—40, 46, 50, 54, 60, 64, 70, 74, 80, 84, and 90.

4 Press SET/DISPLAY.

- Each time you press the button, the tracks to be recorded on the front side (“SIDE-A”) and on the reverse side (“SIDE-B”) appears on the display alternately.

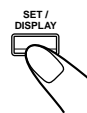

Tracks to be recorded on the reverse side (SIDE-B) appear.

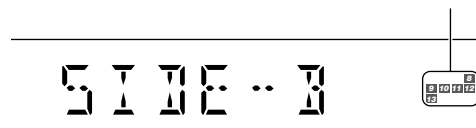

5 Put a recordable cassette of appropriate length into the cassette deck.

6 Press REVERSE MODE so that the Reverse Mode indicator lights up like (Z).

- Without turning on the Reverse Mode, recording will stop when the front side of the tape is recorded.



7 Press CD REC START.

“CD REC” appears, then “TAPE SIDE-A STAND-BY” scroll through the display, and the REC (recording) lamp flashes.

The cassette deck starts recording. About 10 seconds later, the CD player starts playing.

When the recording is done, “CD REC FINISHED” scroll through the display and the REC (recording) lamp goes off. Both the cassette deck and CD player stop automatically.

- If a tape has not been rewound, the cassette deck will rewind the tape before it starts recording.
- A 10-second blank portion is automatically created at the beginning of each side of the tape.



To stop during Auto Edit Recording

Press REC START/STOP or ■ to create a 4-second blank portion on the recording tape. (Remember a 4-second blank is important when using Music Scan—see page 18.)

To cancel Auto Edit Recording

Press CANCEL/DEMO before or after recording.

There are three timers available—DAILY (Daily Timer), REC (Recording Timer), and SLEEP (Sleep Timer).

Before using the timers, you need to set the clock built in the unit. (See page 9.)

Using Daily Timer

With Daily Timer, you can be awakened with your favorite music or radio program.

You can set the timer whether the unit is on or off; however, if Ecology Mode is activated, you cannot set the clock while the unit is off.

How Daily Timer actually works

The unit automatically turns on, sets the volume level to the preset level, and starts playing the specified source when the on-time comes (“DAILY” and the DAILY (Daily Timer) indicator flash just before the on-time, and the DAILY (Daily Timer) indicator continues flashing while the timer is operating). Then, when the off-time comes (“DAILY OFF” flashes just before the off-time), the unit automatically turns off (on standby).

The Daily Timer works everyday automatically. If you do not want to use the Daily Timer, turn off the Daily timer. (See “To turn on or off Daily Timer after its setting is done” on page 23.) The timer setting remains in memory until you change it.

- There is a time limit in doing the following steps. If the setting is canceled before you finish, start from step 1 again.
- To correct a mis-entry while setting the timer, press CANCEL/DEMO.

Before you start...

- *When using a CD as the source to play—*
 - Make sure there is a CD on the selected disc number tray.
- *When using a tape as the source to play—*
 - Make sure that a tape is in the cassette deck.
 - Make sure that the tape direction is correct.
- *When using the external component as the source to play—*
 - Set the timer equipped on the external component at the same time.

On the unit ONLY:

- 1 Press **CLOCK/TIMER** repeatedly until “DAILY” appears on the display.

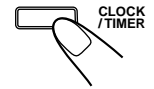

(Timer) indicator lights up and the DAILY (Daily Timer) indicator also starts flashing on the display.



- Each time you press the button, the timer setting modes change as follows:

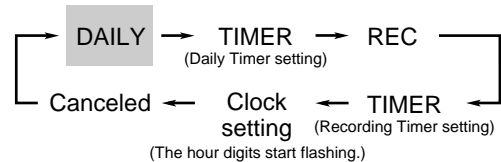

- 2 Press **CLOCK/TIMER** again.

“TIMER” appears for 2 seconds, then the unit enters on-time setting mode.

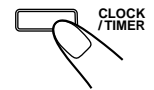

- 3 Set the on-time you want the unit to turn on at.

- 1) Turn **◀◀ / ▶▶** to set the hour, then press **SET/DISPLAY**.

“SET” appears for 1 second.

- 2) Turn **◀◀ / ▶▶** to set the minute, then press **SET/DISPLAY**.

“SET” appears for 1 second, then

the unit enters off-time setting mode.

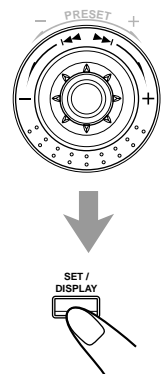

4 Set the off-time you want the unit to turn off (on standby) at.

- 1) Turn **◀◀ / ▶▶** to set the hour, then press **SET/DISPLAY**.
“SET” appears for 1 second.
- 2) Turn **◀◀ / ▶▶** to set the minute, then press **SET/DISPLAY**.
“SET” appears for 1 second, then the unit enters source selecting mode.

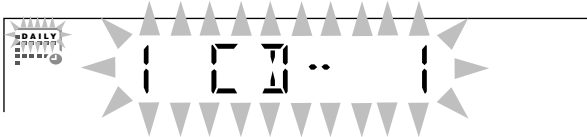

5 Turn **◀◀ / ▶▶ to select the source to play, then press **SET/DISPLAY**.**

- “SET” appears for 1 second.
- The source changes as follows:



- TUNER FM: tunes into a specified preset FM station. → **Go to step 6.**
- TUNER AM: tunes into a specified preset AM station. → **Go to step 6.**
- 1 CD-- 1: plays a disc from a specified track of a specified disc. → **Go to step 6.**
- TAPE: plays a tape in the cassette deck. → **Go to step 7.**
- AUX IN: plays an external source. → **Go to step 7.**

6 When selecting “TUNER FM” or “TUNER AM”

Turn **◀◀ / ▶▶** to select the preset station number, then press **SET/DISPLAY**.
The unit enters volume setting mode.

When selecting “1 CD-- 1”

- 1) Turn **◀◀ / ▶▶** to select the disc number, then press **SET/DISPLAY**.
“SET” appears for 1 second.
- 2) Turn **◀◀ / ▶▶** to set the track number, then press **SET/DISPLAY**.
“SET” appears for 1 second, then the unit enters volume setting mode.

7 Turn **◀◀ / ▶▶ to set the volume level.**

- The volume level changes as follows:

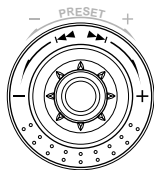
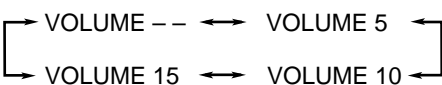

- If you select “VOLUME --,” the volume is set to the last level when the unit has been turned off.

8 Press **SET/DISPLAY to complete the Daily Timer setting.**

The DAILY (Daily Timer) indicator stops flashing and remains lit. “OK ✓” appears on the display for 2 second.
The settings you have done are shown on the display in sequence for your confirmation.

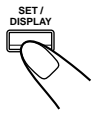

9 Press **⏻/⏻ to turn off the unit (on standby) if you have set the Daily Timer with the unit turned on.**

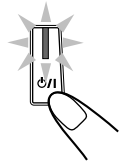

- If the unit is turned on when the on-time comes Daily Timer does not work.
- Even if you unplug the AC power cord or if a power failure occurs
Once you set the timer, the timer setting may remain stored in memory in a few days. In this case, check whether the timer setting still remains or not.

To turn on or off Daily Timer after its setting is done

1 Press **CLOCK/TIMER repeatedly until “DAILY” appears on the display.**

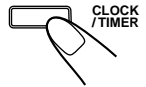

⏻ (Timer) indicator lights up and the DAILY (Daily Timer) indicator starts flashing on the display.

2 To turn off the Daily Timer, press **CANCEL/DEMO.**

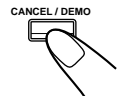

The DAILY (Daily Timer) indicator goes off from the display (“DAILY OFF” appears for a while).

The Daily Timer is canceled, but the setting for the Daily Timer remains in memory.

Or

To turn on the Daily Timer, press **SET/DISPLAY.**

“OK ✓” appears on the display for 2 seconds.
The settings you have done are shown on the display in sequence for your confirmation.

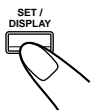

Using Recording Timer

With Recording Timer, you can make a tape of a radio broadcast automatically.

You can set the timer whether the unit is on or off; however, if Ecology Mode is activated, you cannot set the clock while the unit is off.

How Recording Timer actually works

The unit automatically turns on, tunes in to the specified station, sets the volume level to "VOLUME MIN," and starts recording when the on-time comes ("REC" and the REC (Recording Timer) indicator flash just before the on-time, and the REC (Recording Timer) indicator continues flashing while the timer is operating). Then, when the off-time comes ("REC OFF" appears just before the off-time), the unit automatically turns off (on standby).

The timer setting remains in memory until you change it.

- There is a time limit in doing the following steps. If the setting is canceled before you finish, start from step **2** again.
- To correct a mis-entry while setting the timer, press CANCEL/DEMO.

On the unit ONLY:

1 Insert a recordable cassette in with the expose part of the tape down.

2 Press CLOCK/TIMER repeatedly until "REC" appears on the display.

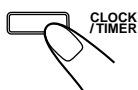

- (Timer) indicator lights up and the REC (Recording Timer) indicator also starts flashing on the display.

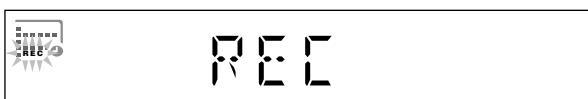

- Each time you press the button, the timer setting modes change as follows:

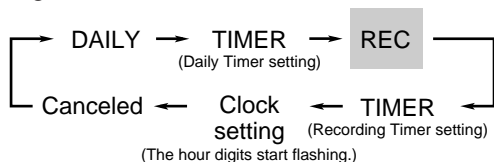

3 Press CLOCK/TIMER again.

"TIMER" appears for 2 seconds, then the unit enters on-time setting mode.

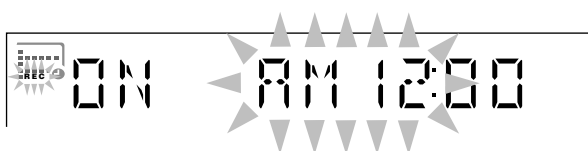
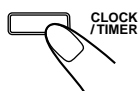

4 Set the on-time you want the unit to turn on at.

- 1) Turn ◀◀ / ▶▶ to set the hour, then press SET/DISPLAY.
"SET" appears for 1 second.
- 2) Turn ◀◀ / ▶▶ to set the minute, then press SET/DISPLAY.
"SET" appears for 1 second, then the unit enters off-time setting mode.

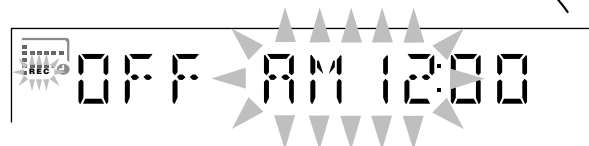
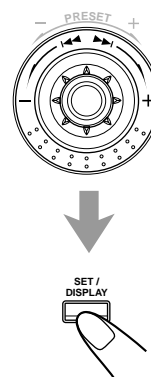

5 Set the off-time you want the unit to turn off (on standby) at.

- 1) Turn ◀◀ / ▶▶ to set the hour, then press SET/DISPLAY.
"SET" appears for 1 second.
- 2) Turn ◀◀ / ▶▶ to set the minute, then press SET/DISPLAY.
"SET" appears for 1 second, then the unit enters preset station selecting mode.

6 Select the preset station.

- 1) Turn ◀◀ / ▶▶ to select the band ("TUNER FM" or "TUNER AM"), then press SET/DISPLAY.
"SET" appears for 1 second.
- 2) Turn ◀◀ / ▶▶ to select a preset channel number, then press SET/DISPLAY.
The REC (Recording Timer) indicator stops flashing and remains lit. "OK ✓" appears on the display for 2 second.
The settings you have done are shown on the display in sequence for your confirmation.

7 Press ⏻/⏺ to turn off the unit (on standby) if necessary.

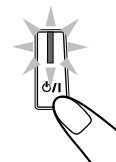

- **If you want to listen to another source while recording**
Press REC START/STOP or ■ to stop recording. Without stopping it, you cannot change the source.
- **Even if you unplug the AC power cord or if a power failure occurs**
Once you set the timer, the timer setting may remain stored in memory in a few days. In this case, check whether the timer setting still remains or not.



To turn on or off Recording Timer after its setting is done

1 Press CLOCK/TIMER repeatedly until “REC” appears on the display.

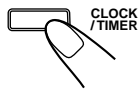

⬇ (Timer) indicator lights up and the REC (Recording Timer) indicator starts flashing on the display.

2 To turn off the Recording Timer, press CANCEL/DEMO.

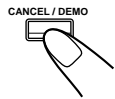

The REC (Recording Timer) indicator goes off from the display (“REC OFF” appears on the display for 2 seconds).

The Recording Timer is canceled, but the setting for the Recording Timer remains in memory.

Or

To turn on the Recording Timer, press SET/DISPLAY.

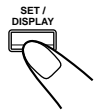

“OK ✓” appears on the display for 2 seconds.

The settings you have done are shown on the display in sequence for your confirmation.

Timer Priority

Since each timer can be set separately, you may wonder what happens if the setting for these timers overlaps.

Below are some examples.

Recording Timer has priority over Daily Timer and Sleep Timer.

- If Daily Timer is set to come on while Recording Timer is operating, Daily Timer will not come on at all.

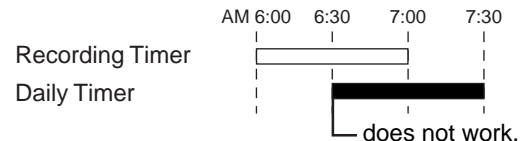

- If Recording Timer is set to come on while Sleep Timer is operating, Sleep Timer will be canceled.

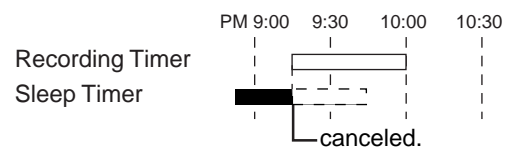

Using Sleep Timer

With Sleep Timer, you can fall asleep to music. You can set Sleep Timer only while the unit is turned on.

How Sleep Timer actually works

The unit automatically turns off after the specified time length passes.

On the remote control ONLY:

1 Press SLEEP.



The time length until the shut-off time appears and the SLEEP indicator starts flashing on the display.

- Each time you press the button, the time length changes as follows:

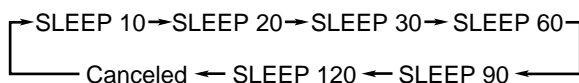

2 Wait for about 5 seconds after specifying the time length.

The SLEEP indicator stops flashing and remains lit.

To check the remaining time until the shut-off time, press SLEEP once so that the remaining time (minute) until the shut-off time appears for about 5 seconds.

To change the shut-off time, press SLEEP repeatedly until the desired time length appears on the display.

To cancel the setting, press SLEEP repeatedly so that the SLEEP indicator goes off.

- Sleep Timer is also canceled when you turn off the unit.

Maintenance



To get the best performance of the unit, keep your discs, tapes, and mechanism clean.

General Notes

In general, you will have the best performance by keeping your discs and the mechanism clean.

- Store discs in their cases, and keep them in cabinets or on shelves.
- Keep the unit's disc trays closed when not in use.

Handling discs



- Remove the disc from its case by holding it at the edge while pressing the center hole lightly.
- Do not touch the shiny surface of the disc, or bend the disc.
- Put the disc back in its case after use to prevent warping.

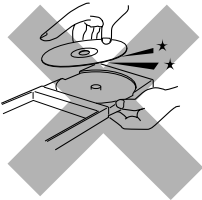

- Be careful not to scratch the surface of the disc when placing it back in its case.
- Avoid exposure to direct sunlight, temperature extremes, and moisture.



To clean the disc
Wipe the disc with a soft cloth in a straight line from center to edge.



DO NOT use any solvent—such as conventional record cleaner, spray, thinner, or benzine—to clean the disc.

Handling cassette tapes

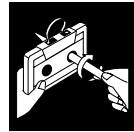

- If the tape is loose in its cassette, take up the slack by inserting a pencil in one of the reels and rotating.
- If the tape is loose, it may get stretched, cut, or caught in the cassette.



- Be careful not to touch the tape surface.



- Avoid the following places to store the tape:
 - In dusty places
 - In direct sunlight or heat
 - In moist areas
 - Near a magnet

Cleaning the unit

• Stains on the unit

Should be wiped off with a soft cloth. If the unit is heavily stained, wipe it with a cloth soaked in water diluted neutral detergent and wrung well, then wipe clean with a dry cloth.

• Since the unit may deteriorate in quality, become damaged or get its paint peeled off, be careful about the followings.

- DO NOT wipe it with a hard cloth.
- DO NOT wipe it strong.
- DO NOT wipe it with thinner or benzine.
- DO NOT apply any volatile substance such as insecticides to it.
- DO NOT allow any rubber or plastic to remain in contact with it for a long time.

Troubleshooting



If you are having a problem with your unit, check this list for a possible solution before calling for service. If you cannot solve the problem from the hints given here, or the unit has been physically damaged, call a qualified person, such as your dealer, for service.

	Symptom	Cause	Action
GENERAL	Unable to cancel the demonstration.	The button other than CANCEL/DEMO is pressed to cancel the display demonstration temporarily.	Press CANCEL/DEMO on the unit. (See page 8.)
	No sound is heard.	Connections are incorrect or loose.	Check all connections and make corrections. (See pages 6 to 8.)
	Operations are disabled.	The built-in microprocessor may malfunction due to external electrical interference.	Unplug the AC power cord and then plug it back in.
	Unable to operate the unit from the remote control.	<ul style="list-style-type: none"> The path between the remote control and the remote sensor on the unit is blocked. The batteries are exhausted. 	<ul style="list-style-type: none"> Remove the obstruction. Replace the batteries.
TUNER	Hard to listen to broadcasts because of noise.	<ul style="list-style-type: none"> Antennas are disconnected. The AM loop antenna is too close to the unit. The FM antenna is not properly extended and positioned. 	<ul style="list-style-type: none"> Reconnect the antennas correctly and securely. Change the position and direction of the AM loop antenna. Extend the FM antenna at the best position.
	CD	The disc sound is discontinuous.	The disc is scratched or dirty.
The disc tray does not open or close.		<ul style="list-style-type: none"> The AC power cord is not plugged in. Trays are locked. 	<ul style="list-style-type: none"> Plug the AC power cord. Unlock the trays. (See page 17.)
TAPE	The disc does not play.	The disc is placed upside down.	Place the disc with the label side up.
	The cassette holders cannot be opened.	Power supply from the AC power cord has been cut off while the tape was running.	Turn on the unit.
REC	Impossible to record.	Small tabs on the back of the cassette are removed.	Cover the holes with adhesive tape. (See page 19.)

Specifications

Amplifier section—CA-HXZ1

Output Power

SUBWOOFERS: 130 W per channel, min. RMS, driven into 6 Ω at 63 Hz with no more than 10% total harmonic distortion.

MAIN SPEAKERS: 55 W per channel, min. RMS, driven into 6 Ω at 1 kHz with no more than 10% total harmonic distortion.

Audio input sensitivity/Impedance

(Measured at 1 kHz, with tape recording signal 300 mV)

AUX: 390 mV/50 k Ω

Digital output: CD OPTICAL DIGITAL OUTPUT

Signal wave length: 660 nm

Output level: -15 dBm to -12 dBm

Speakers/Impedance:

SUBWOOFERS: 6 Ω – 16 Ω

MAIN SPEAKERS: 6 Ω – 16 Ω

Tuner

FM tuning range: 87.5 MHz – 108.0 MHz

AM tuning range: 530 kHz – 1 710 kHz

CD player

CD capacity: 3 CDs

Dynamic range: 85 dB

Signal-to-noise ratio: 90 dB

Wow and flutter: Immeasurable

Cassette deck

Frequency response

Normal (type I): 50 Hz – 14 000 Hz

Wow and flutter: 0.15% (WRMS)

General

Power requirement: AC 120 V \sim , 60 Hz

Power consumption: 165 W/210 VA (at operation)

24 W (on standby with Ecology Mode off)

1.3 W (on standby with Ecology Mode on)

Dimensions (approx.): 205 mm x 370 mm x 370 mm (W/H/D)

(8¹/₈ in. x 14⁵/₈ in. x 14⁵/₈ in.)

Mass (approx.): 10.0 kg (22.1 lbs)

Supplied accessories

See page 6.

Speaker section—SP-HXZ1

Type: 3-Way 4-Speaker Bass-Reflex Type Twin Hyper Power-Drive Subwoofers and Front Twin Woofer

Speaker units: Subwoofer: 16 cm (6⁵/₁₆ in.) cone x1
Woofer: 10 cm (3¹⁵/₁₆ in.) cone x2
Tweeter: 5 cm (2 in.) cone x1

Power handling capacity: Subwoofer: 130 W

Main speaker: 55 W

Impedance: Subwoofer: 6 Ω

Main speaker: 6 Ω

Frequency range: Subwoofer: 30 Hz – 120 Hz

Main speaker: 75 Hz – 32 000 Hz

Sound pressure level: Subwoofer: 78 dB/W•m

Main speaker: 86 dB/W•m

Dimensions (approx.): 217 mm x 432 mm x 365 mm (W/H/D)

(8⁹/₁₆ in. x 17¹/₁₆ in. x 14³/₈ in.)

Mass (approx.): 7.6 kg (16.8 lbs) each

Design and specifications are subject to change without notice.

Authorized Service Centers

QUALITY **JVC**[®] SERVICE

HOW TO LOCATE YOUR JVC SERVICE CENTER

TOLL FREE: 1 (800) 537-5722

<http://www.jvc.com>

Dear Customer,

In order to receive the most satisfaction from your purchase, please read the instruction booklet before operating the unit. In the event that repairs are necessary, please call 1 (800)537-5722 for your nearest authorized servicer or visit our website at **www.JVC.com**

Remember to retain your Bill of Sale for Warranty Service.

Do not service the television yourself

Caution

To prevent electrical shock, do not open the cabinet. There are no user serviceable parts inside. Please refer to qualified service personnel for repairs.

Accessories

To purchase accessories for your JVC product, please call toll free: 1 (800)882-2345 or on the web at **www.JVC.com**



LIMITED WARRANTY

AUDIO-1

JVC COMPANY OF AMERICA warrants this product and all parts thereof, except as set forth below ONLY TO THE ORIGINAL PURCHASER AT RETAIL to be FREE FROM DEFECTIVE MATERIALS AND WORKMANSHIP from the date of original retail purchase for the period as shown below. ("The Warranty Period")

PARTS	1 YR	LABOR	1 YR
-------	-------------	-------	-------------

THIS LIMITED WARRANTY IS VALID ONLY IN THE FIFTY (50) UNITED STATES, THE DISTRICT OF COLUMBIA AND IN COMMONWEALTH OF PUERTO RICO.

WHAT WE WILL DO:

If this product is found to be defective, JVC will repair or replace defective parts at no charge to the original owner. Such repair and replacement services shall be rendered by JVC during normal business hours at JVC authorized service centers. Parts used for replacement are warranted only for the remainder of the Warranty Period. All products and parts thereof may be brought to a JVC authorized service center on a carry-in basis except for Television sets having a screen size 25 inches and above which are covered on an in-home basis.

WHAT YOU MUST DO FOR WARRANTY SERVICE:

Return your product to a JVC authorized service center with a copy of your bill of sale. For your nearest JVC authorized service center, please call toll free: (800) 537-5722.

If service is not available locally, box the product carefully, preferably in the original carton, and ship, insured, with a copy of your bill of sale plus a letter of explanation of the problem to the nearest JVC Factory Service Center, the name and location of which will be given to you by the toll-free number.

If you have any questions concerning your JVC Product, please contact our Customer Relations Department.

WHAT IS NOT COVERED:

This limited warranty provided by JVC does not cover:

1. Products which have been subject to abuse, accident, alteration, modification, tampering, negligence, misuse, faulty installation, lack of reasonable care, or if repaired or serviced by anyone other than a service facility authorized by JVC to render such service, or if affixed to any attachment not provided with the products, or if the model number or serial number has been altered, tampered with, defaced or removed;
2. Initial installation and installation and removal for repair;
3. Operational adjustments covered in the Owner's Manual, normal maintenance, video and audio head cleaning;
4. Damage that occurs in shipment, due to act of God, and cosmetic damage;
5. Signal reception problems and failures due to line power surge;
6. Video Pick-up Tubes/CCD Image Sensor, Cartridge, Stylus (Needle) are covered for 90 days from the date of purchase;
7. Accessories
8. Batteries (except that Rechargeable Batteries are covered for 90 days from the date of purchase);

There are no express warranties except as listed above.

THE DURATION OF ANY IMPLIED WARRANTIES, INCLUDING THE IMPLIED WARRANTY OF MERCHANTABILITY, IS LIMITED TO THE DURATION OF THE EXPRESS WARRANTY HEREIN.

JVC SHALL NOT BE LIABLE FOR THE LOSS OF USE OF THE PRODUCT, INCONVENIENCE, LOSS OR ANY OTHER DAMAGES, WHETHER DIRECT, INCIDENTAL OR CONSEQUENTIAL (INCLUDING, WITHOUT LIMITATION, DAMAGE TO TAPES, RECORDS OR DISCS) RESULTING FROM THE USE OF THIS PRODUCT, OR ARISING OUT OF ANY BREACH OF THIS WARRANTY. ALL EXPRESS AND IMPLIED WARRANTIES, INCLUDING THE WARRANTIES OF MERCHANTABILITY AND FITNESS FOR PARTICULAR PURPOSE, ARE LIMITED TO THE WARRANTY PERIOD SET FORTH ABOVE.

Some states do not allow the exclusion of incidental or consequential damages or limitations on how long an implied warranty lasts, so these limitations or exclusions may not apply to you. This warranty gives you specific legal rights and you may also have other rights which vary from state to state.

JVC COMPANY OF AMERICA 1700 Valley Road
 DIVISION OF JVC AMERICAS CORP. Wayne, NJ 07470

REFURBISHED PRODUCTS CARRY A SEPARATE WARRANTY, THIS WARRANTY DOES NOT APPLY. FOR DETAILS OF REFURBISHED PRODUCT WARRANTY, PLEASE REFER TO THE REFURBISHED PRODUCT WARRANTY INFORMATION PACKAGED WITH EACH REFURBISHED PRODUCT.

For customer use:

Enter below the Model No. which is located either on the rear, bottom or side of the cabinet. Retain this information for future reference.

Model No. : _____ Serial No. : _____

Purchase data : _____ Name of dealer : _____



JVC
VICTOR COMPANY OF JAPAN, LIMITED

NOTICE/ AVIS

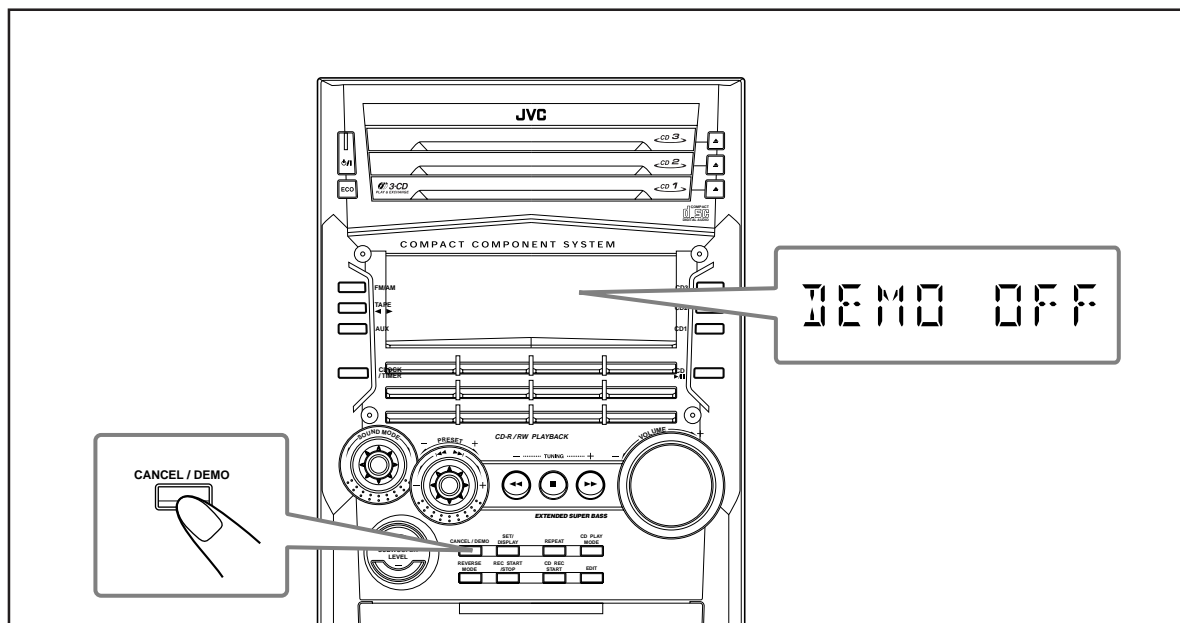

English

Demonstration

When connecting the AC power cord into a wall outlet, the unit automatically starts the demonstration.

To cancel the demonstration, press and hold CANCEL/DEMO until “DEMO OFF” appears on the display.

- For more detailed information about the demonstration, refer to the Instructions manual on page 8.

Français

Démonstration

Quand vous connectez le cordon d'alimentation secteur sur une prise secteur murale, l'appareil commence automatiquement de démonstration.

Pour annuler la démonstration, maintenez pressée CANCEL/DEMO jusqu'à ce que “DEMO OFF” apparaisse sur l'affichage.

- Pour plus d'informations à propos de la démonstration, référez-vous à Manuel d'instructions aux page 8.

JVC



COMPACT COMPONENT SYSTEM

SYSTEME DE COMPOSANTS COMPACT

HX-Z1 — Consists of CA-HXZ1 and SP-HXZ1

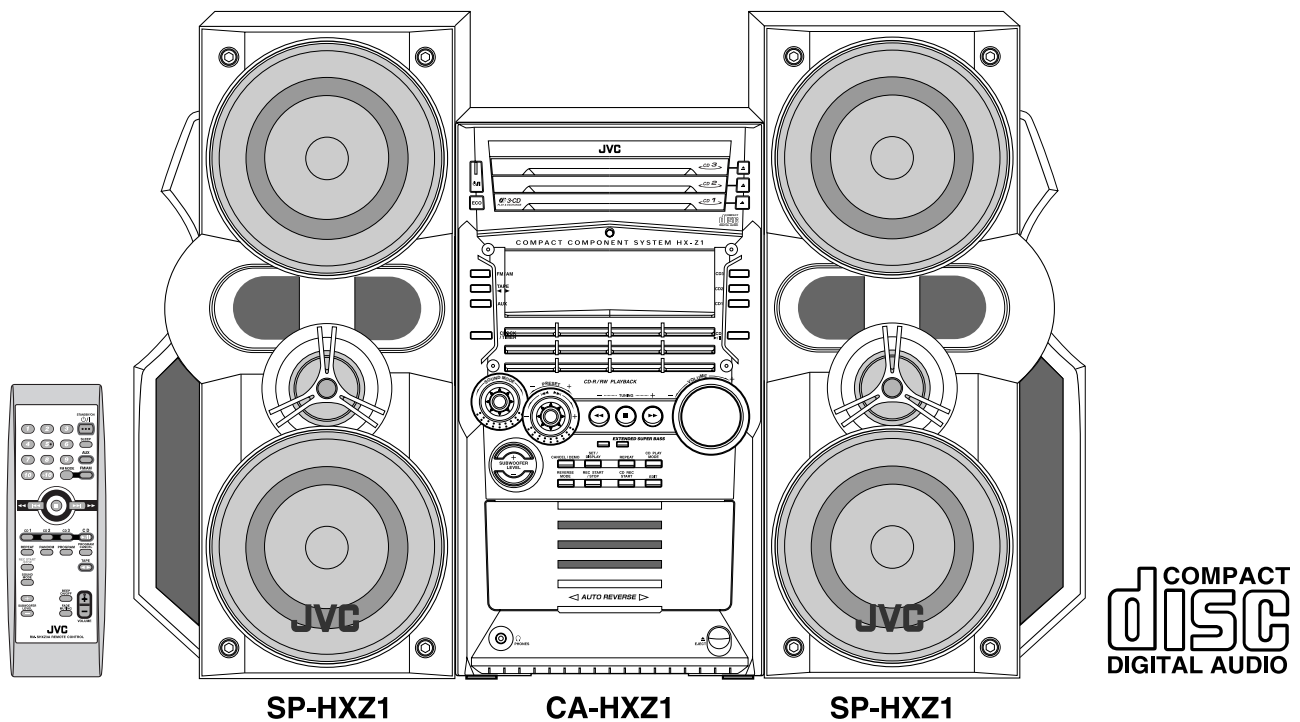

SP-HXZ1

CA-HXZ1

SP-HXZ1

COMPACT
disc
DIGITAL AUDIO

INSTRUCTIONS MANUEL D'INSTRUCTIONS

For Customer Use:

Enter below the Model No. and Serial No. which are located either on the rear, bottom or side of the cabinet. Retain this information for future reference.

Model No. _____

Serial No. _____

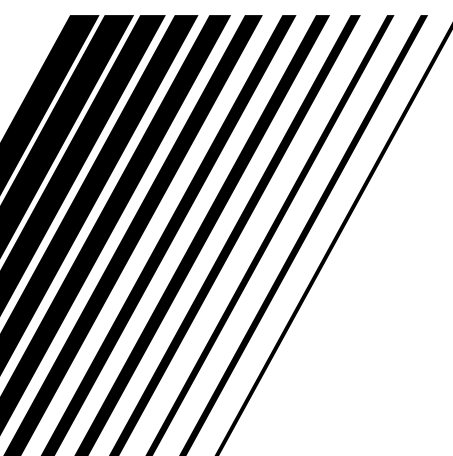

Warnings, Cautions and Others

Mises en garde, précautions et indications diverses

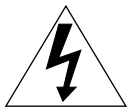

The lightning flash with arrowhead symbol, within an equilateral triangle is intended to alert the user to the presence of uninsulated "dangerous voltage" within the product's enclosure that may be of sufficient magnitude to constitute a risk of electric shock to persons.



The exclamation point within an equilateral triangle is intended to alert the user to the presence of important operating and maintenance (servicing) instructions in the literature accompanying the appliance.

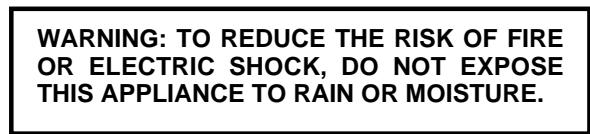

CAUTION

To reduce the risk of electrical shocks, fire, etc.:

1. Do not remove screws, covers or cabinet.
2. Do not expose this appliance to rain or moisture.

ATTENTION

Afin d'éviter tout risque d'électrocution, d'incendie, etc.:

1. Ne pas enlever les vis ni les panneaux et ne pas ouvrir le coffret de l'appareil.
2. Ne pas exposer l'appareil à la pluie ni à l'humidité.

For U.S.A.

This equipment has been tested and found to comply with the limits for a Class B digital device, pursuant to part 15 of the FCC Rules. These limits are designed to provide reasonable protection against harmful interference in a residential installation.

This equipment generates, uses and can radiate radio frequency energy and, if not installed and used in accordance with the instructions, may cause harmful interference to radio communications. However, there is no guarantee that interference will not occur in a particular installation. If this equipment does cause harmful interference to radio or television reception, which can be determined by turning the equipment off and on, the user is encouraged to try to correct the interference by one or more of the following measures:

- Reorient or relocate the receiving antenna.
- Increase the separation between the equipment and receiver.
- Connect the equipment into an outlet on a circuit different from that to which the receiver is connected.
- Consult the dealer or an experienced radio/TV technician for help.

Caution— (standby/on) button!

Disconnect the mains plug to shut the power off completely. The  (standby/on) button in any position does not disconnect the mains line. The power can be remote controlled.

Attention—Commutateur (attente/sous tension)!

Déconnecter la fiche de secteur pour couper complètement le courant. Le commutateur  (attente/sous tension) ne coupe jamais complètement la ligne de secteur, quelle que soit sa position. Le courant peut être télécommandé.

For Canada/pour le Canada

CAUTION: TO PREVENT ELECTRIC SHOCK, MATCH WIDE BLADE OF PLUG TO WIDE SLOT, FULLY INSERT.

ATTENTION: POUR EVITER LES CHOCS ELECTRIQUES, INTRODUIRE LA LAME LA PLUS LARGE DE LA FICHE DANS LA BORNE CORRESPONDANTE DE LA PRISE ET POUSSER JUSQU'AU FOND.

For Canada/pour le Canada

THIS DIGITAL APPARATUS DOES NOT EXCEED THE CLASS B LIMITS FOR RADIO NOISE EMISSIONS FROM DIGITAL APPARATUS AS SET OUT IN THE INTERFERENCE-CAUSING EQUIPMENT STANDARD ENTITLED "DIGITAL APPARATUS," ICES-003 OF THE DEPARTMENT OF COMMUNICATIONS.

CET APPAREIL NUMERIQUE RESPECTE LES LIMITES DE BRUITS RADIOELECTRIQUES APPLICABLES AUX APPAREILS NUMERIQUES DE CLASSE B PRESCRITES DANS LA NORME SUR LE MATERIEL BROUILLEUR: "APPAREILS NUMERIQUES", NMB-003 EDICTEE PAR LE MINISTRE DES COMMUNICATIONS.

1. CLASS 1 LASER PRODUCT
2. **DANGER:** Invisible laser radiation when open and interlock failed or defeated. Avoid direct exposure to beam.
3. **CAUTION:** Do not open the top cover. There are no user serviceable parts inside the Unit; leave all servicing to qualified service personnel.

1. PRODUIT LASER CLASSE 1
2. **ATTENTION:** Radiation laser invisible quand l'appareil est ouvert ou que le verrouillage est en panne ou désactivé. Eviter une exposition directe au rayon.
3. **ATTENTION:** Ne pas ouvrir le couvercle du dessus. Il n'y a aucune pièce utilisable à l'intérieur. Laisser à un personnel qualifié le soin de réparer votre appareil.

Introduction

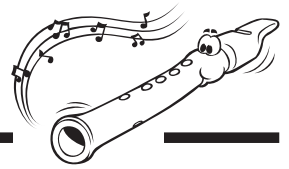

We would like to thank you for purchasing one of our JVC products. Before operating this unit, read this manual carefully and thoroughly to obtain the best possible performance from your unit, and retain this manual for future reference.

About This Manual

This manual is organized as follows:

- The manual mainly explains operations using the buttons and controls on the unit. You can also use the buttons on the remote control if they have the same or similar names (or marks) as those on the unit. If operation using the remote control is different from that using the unit, it is then explained.
- Basic and common information that is the same for many functions is grouped in one place, and is not repeated in each procedure. For instance, we do not repeat the information about turning on/off the unit, setting the volume, changing the sound effects, and others, which are explained in the section “Common Operations” on pages 9 to 11.
- The following marks are used in this manual:



Gives you warnings and cautions to prevent from damage or risk of fire/electric shock. Also gives you information which is not good for obtaining the best possible performance from the unit.



Gives you information and hints you had better know.

Precautions

Installation

- Install in a place which is level, dry and neither too hot nor too cold—between 5°C (41°F) and 35°C (95°F).
- Install the unit in a location with adequate ventilation to prevent internal heat buildup in the unit.
- Leave sufficient distance between the unit and the TV.
- Keep the speakers away from the TV to avoid interference with TV.



DO NOT install the unit in a location near heat sources, or in a place subject to direct sunlight, excessive dust or vibration.

Power sources

- When unplugging from the wall outlet, always pull the plug, not the AC power cord.



DO NOT handle the AC power cord with wet hands.

Moisture condensation

Moisture may condense on the lens inside the unit in the following cases:

- After heating start in the room
 - In a damp room
 - If the unit is brought directly from a cold to a warm place
- Should this occur, the unit may malfunction. In this case, leave the unit turned on for a few hours until the moisture evaporates, unplug the AC power cord, and then plug it in again.

Internal heat

A cooling fan is mounted on the rear panel to prevent heat buildup inside the unit.



For safety, observe the following carefully:

- Make sure there is good ventilation around the unit. Poor ventilation could overheat and damage the unit.
- DO NOT block the cooling fan and the ventilation openings or holes. If they are blocked by a newspaper or cloth, etc., the heat may not be able to get out.

Others

- Should any metallic object or liquid fall into the unit, unplug the unit and consult your dealer before operating any further.
- If you are not going to operate the unit for an extended period of time, unplug the AC power cord from the wall outlet.



DO NOT disassemble the unit since there are no user serviceable parts inside.

If anything goes wrong, unplug the AC power cord and consult your dealer.

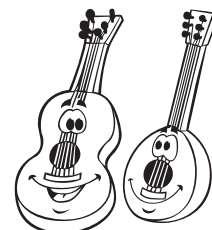

Location of the Buttons and Controls	3
Front Panel	3
Remote Control	5
Getting Started	6
Supplied Accessories	6
Putting the Batteries into the Remote Control	6
Connecting Antennas	6
Connecting Speakers	7
Connecting Other Equipment	8
Canceling the Demonstration	8
Common Operations	9
Turning On or Off the Power	9
Saving the Power Consumption while on Standby	
—Ecology Mode	9
Setting the Clock	9
Selecting the Sources	10
Adjusting the Volume	10
Reinforcing the Bass Sound	10
Selecting the Sound Modes	10
Creating Your Own Sound Mode—User Mode	11
Turning On or Off the Key-touch Tone	11
Listening to FM and AM Broadcasts	12
Tuning in to a Station	12
Presetting Stations	12
Tuning in to a Preset Station	12
Playing Back CDs (CD/CD-R/CD-RW)	13
Loading CDs	13
Playing Back the Entire Discs—Continuous Play ...	14
Basic CD Operations	14
Programming the Playing Order of the Tracks	
—Program Play	15
Playing at Random—Random Play	16
Repeating Tracks or CDs—Repeat Play	17
Prohibiting Disc Ejection—Tray Lock	17
Playing Back Tapes	18
Playing Back a Tape	18
Locating the Beginning of a Song—Music Scan	18
Recording	19
Recording on a Tape	19
CD Synchronized Recording	20
■ CD Direct Recording	20
■ Auto Edit Recording	21
Using the Timers	22
Using Daily Timer	22
Using Recording Timer	24
Using Sleep Timer	25
Timer Priority	25
Maintenance	26
Troubleshooting	27
Specifications	28

Location of the Buttons and Controls

Become familiar with the buttons and controls on your unit.

Front Panel

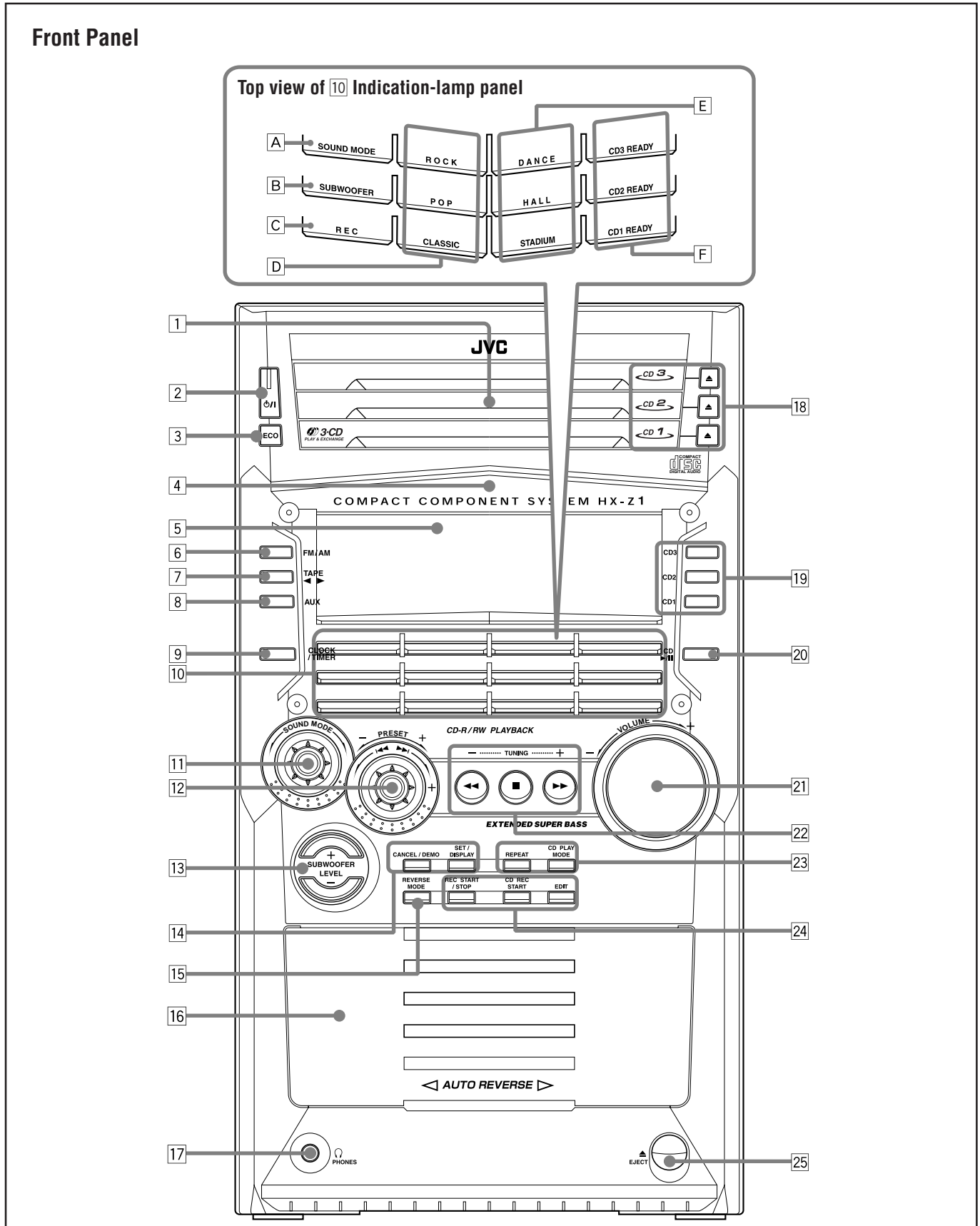

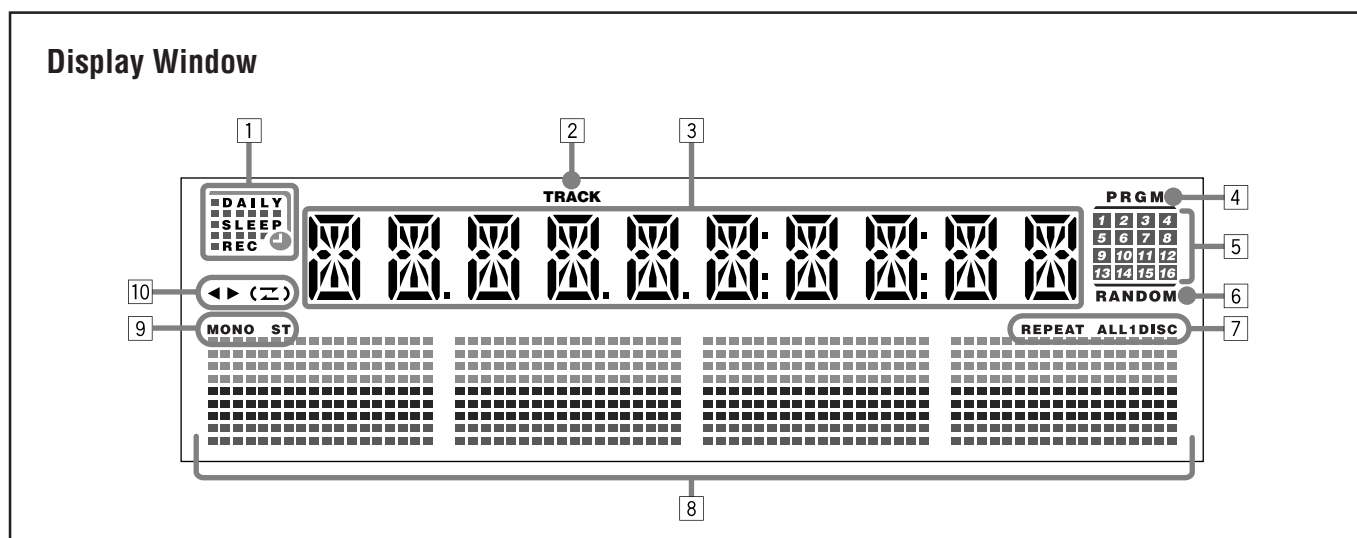

See pages in the parentheses for details.

Front Panel

- 1 Disc trays
- 2 O/I (standby/on) button and lamp (9, 23, 24)
- 3 ECO (Ecology) button (9)
- 4 Remote sensor
- 5 Display window
- 6 FM/AM button (10, 12)
Pressing this button also turns on the unit.
- 7 TAPE $\blacktriangleleft \blacktriangleright$ button (10, 18, 19)
Pressing this button also turns on the unit.
- 8 AUX button (10)
Pressing this button also turns on the unit.
- 9 CLOCK/TIMER button (9, 22 – 25)
- 10 Indication-lamp panel
 - A SOUND MODE lamp (10)
 - B SUBWOOFER lamp (10)
 - C REC (recording) lamp (19 – 21)
 - D SEA (Sound Effect Amplifier) mode lamps (10)
 - ROCK, POP, and CLASSIC lamps
 - E Surround mode lamps (10)
 - DANCE, HALL, and STADIUM lamps
 - F CD ready lamps (13)
 - CD1 READY, CD2 READY, and CD3 READY lamps
- 11 SOUND MODE control (10)
- 12 PRESET + / – control (12)
 $\blacktriangleleft \blacktriangleleft / \blacktriangleright \blacktriangleright$ (reverse skip/forward skip) control (9, 11, 14 – 16, 21 – 24)
- 13 SUBWOOFER LEVEL + / – buttons (10)
- 14 Setting buttons (8, 9, 11, 12, 15, 16, 21 – 25)
 - CANCEL/DEMO and SET/DISPLAY buttons
- 15 REVERSE MODE button (18 – 21)
- 16 Cassette holder (18 – 21)
- 17 PHONES (Q) jack (10)
- 18 \blacktriangle (Disc tray open/close) (CD1, CD2, and CD3) buttons (13, 14, 17)
Pressing one of these buttons also turns on the unit.
- 19 Disc number (CD1, CD2, and CD3) buttons (14, 15, 20, 21)
Pressing one of these buttons also turns on the unit.
- 20 CD $\blacktriangleright / \text{II}$ button (10, 14 – 16, 21)
Pressing this button also turns on the unit.
- 21 VOLUME + / – control (10)
- 22 TUNING + / – buttons (12)
 - $\blacktriangleleft \blacktriangleleft / \blacktriangleright \blacktriangleright$ (reverse search/forward search) buttons (11, 14, 18)
 - \blacksquare (stop) button (14 – 21, 24)
- 23 CD play mode buttons (15 – 17)
 - CD PLAY MODE and REPEAT buttons
- 24 Recording buttons (19 – 21, 24)
 - REC START/STOP, CD REC START, and EDIT buttons
- 25 \blacktriangle EJECT button for cassette deck (18 – 20)

Display Window

- 1 Timer indicators
 - DAILY (Daily Timer), SLEEP (Sleep Timer), REC (Recording Timer), and O (Timer) indicators
- 2 TRACK indicator
- 3 Main display
 - Shows the source name, frequency, etc.
- 4 PRGM (program) indicator
- 5 CD track number (1 – 16) indicators
- 6 RANDOM indicator
- 7 REPEAT (ALL/1/DISC) indicators
- 8 Audio level indicator
When one of the 6 preset sound modes is activated, these will function as display illumination. For details, see “Selecting the Sound Modes” on pages 10 and 11.
- 9 Tuner operation indicators
 - MONO and ST (stereo) indicators
- 10 Tape operation indicators
 - $\blacktriangleleft \blacktriangleright$ (tape direction) and Z (reverse mode) indicators



Remote Control

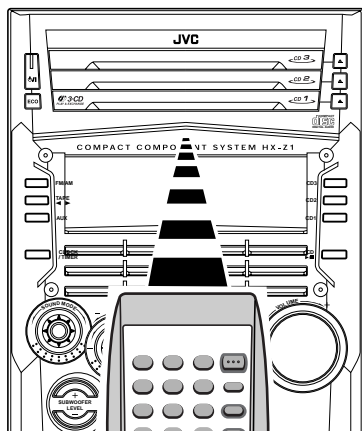
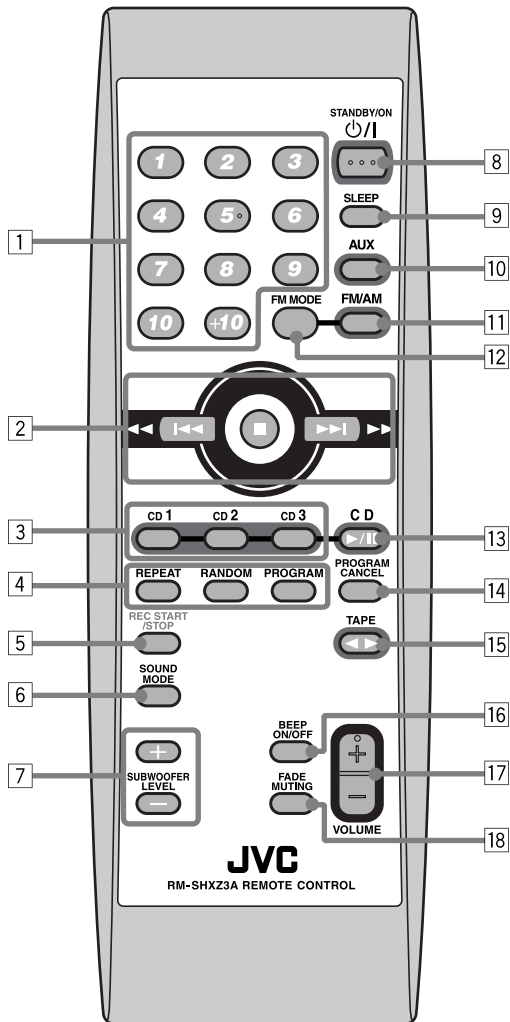

When using the remote control, point it at the remote sensor on the front panel.

Remote Control

- 1 Number buttons (12, 14, 15)
- 2 ◀◀ (◀◀) (reverse skip/reverse search) button (12, 14, 16, 18)
 - (stop) button (14 – 16, 18 – 21, 24)
 - ▶▶ (▶▶) (forward skip/forward search) button (12, 14, 16, 18)
- 3 Disc number (CD1, CD2, and CD3) buttons (14, 15)
- 4 CD play mode buttons (15 – 17)
 - REPEAT, RANDOM and PROGRAM buttons
- 5 REC START/STOP button (19, 21, 24)
- 6 SOUND MODE button (10)
- 7 SUBWOOFER LEVEL +/- buttons (10)
- 8 STANDBY/ON ⏻ button (9)
- 9 SLEEP button (25)
- 10 AUX button (10)
- 11 FM/AM button (10, 12)
- 12 FM MODE button (12)
- 13 CD ▶/|| button (10, 14 – 16)
- 14 PROGRAM CANCEL button (16)
- 15 TAPE ◀▶ button (10, 18, 19)
- 16 BEEP ON/OFF button (8, 11)
- 17 VOLUME +/- button (10)
- 18 FADE MUTING button (10)

Supplied Accessories

Make sure that you have all the following items.
The number in the parentheses indicates the quantity of the pieces supplied.

- AM loop antenna (1)
- FM antenna (1)
- Remote control (1)
- Batteries (2)

If anything is missing, consult your dealer immediately.

Putting the Batteries into the Remote Control

Insert the batteries—R6(SUM-3)/AA(15F)—into the remote control, by matching the polarity (+ and –) on the batteries with the + and – markings on the battery compartment. When the remote control can no longer operate the unit, replace both batteries at the same time.

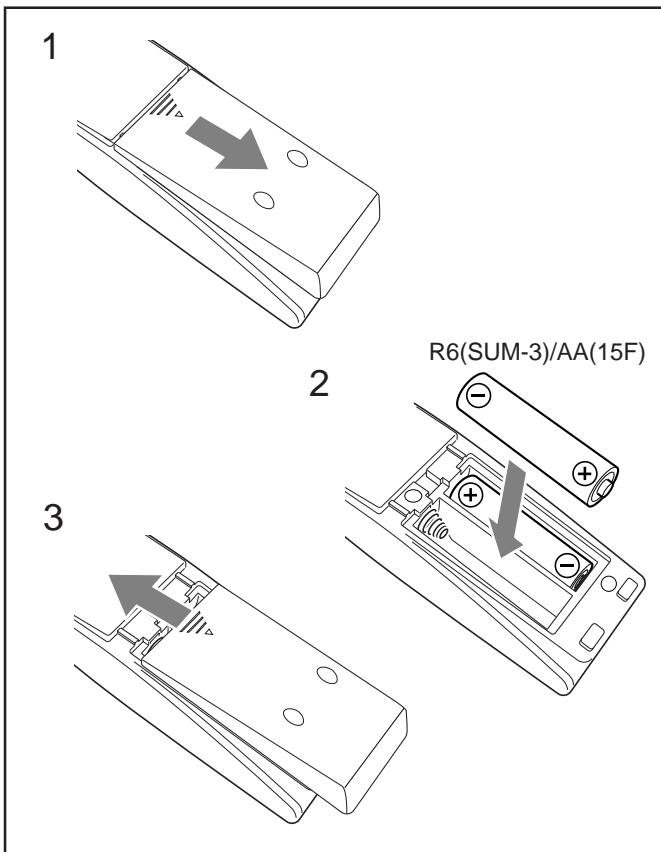

- DO NOT use an old battery together with a new one.
- DO NOT use different types of batteries together.
- DO NOT expose batteries to heat or flame.
- DO NOT leave the batteries in the battery compartment when you are not going to use the remote control for an extended period of time. Otherwise, it will be damaged from battery leakage.

Connecting Antennas

FM antenna

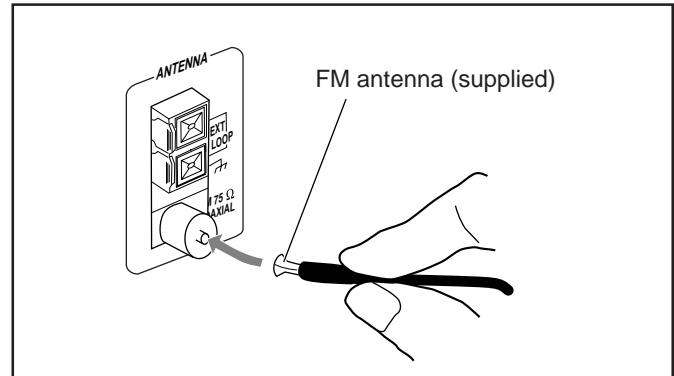

- 1 Attach the FM antenna to the FM 75 Ω COAXIAL terminal.
- 2 Extend the FM antenna.
- 3 Fasten it up in the position which gives you the best reception, then fix it on the wall, etc.



About the supplied FM antenna

The FM antenna supplied with this unit can be used as temporary measure. If reception is poor, you can connect an outdoor FM antenna.

To connect an outdoor FM antenna

Before connecting it, disconnect the supplied FM antenna.

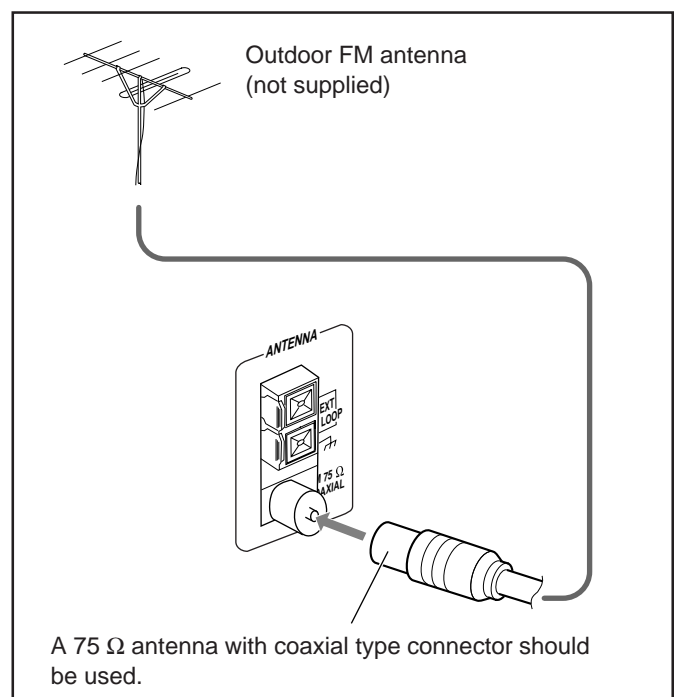

AM antenna

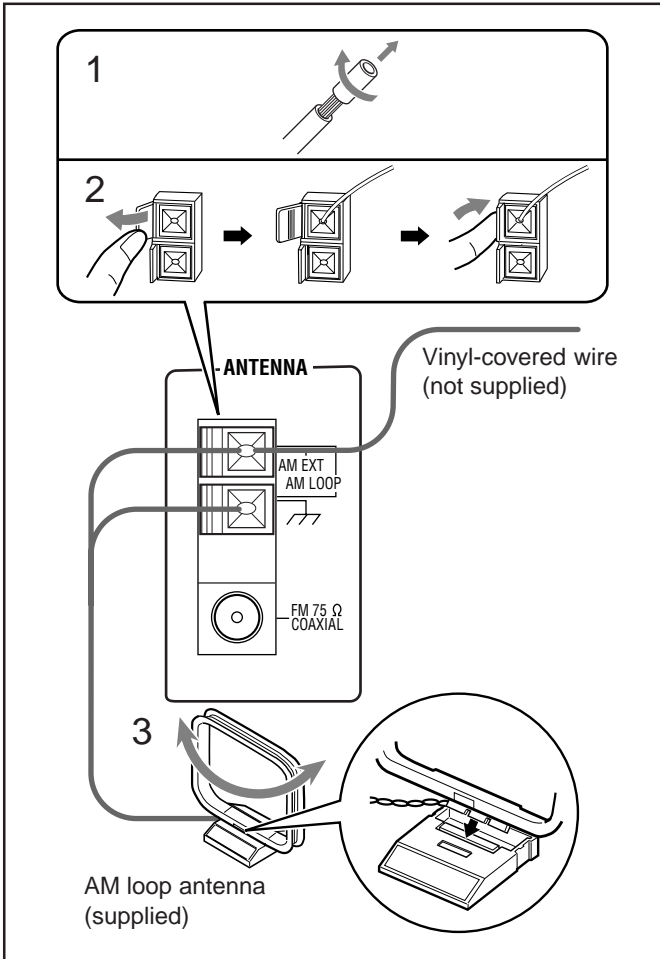

- 1 If cords are covered with insulation, twist the core of the cord at the end of each cord, then remove the insulation.
- 2 Connect the AM loop antenna to the AM LOOP terminals as illustrated.
- 3 Turn the AM loop antenna until you have the best reception.

To connect an outdoor AM antenna

When reception is poor, connect a single vinyl-covered wire to the AM EXT terminal and extend it horizontally. The AM loop antenna must remain connected.



For better reception of both FM and AM

- Make sure the antenna conductors do not touch any other terminals and connecting cords.
- Keep the antennas away from metallic parts of the unit, connecting cords, and the AC power cord.

Connecting Speakers

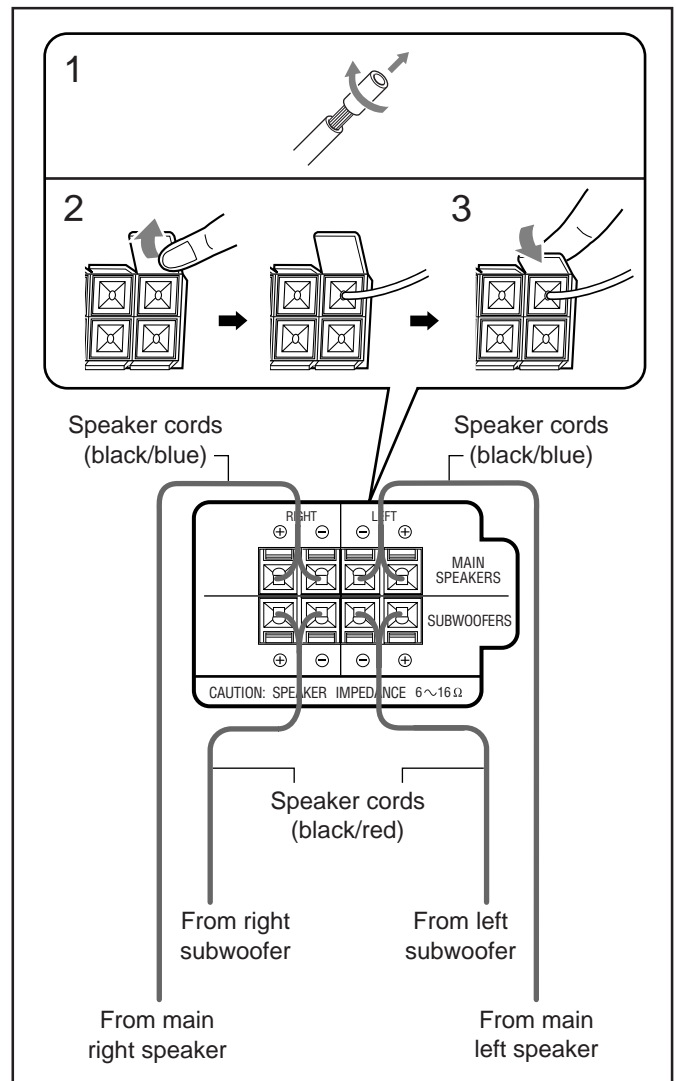

- 1 If cords are covered with insulation, twist the core of the cord at the end of each cord, then remove the insulation.
- 2 Insert the end of the speaker cord into the terminal as illustrated.
Match the same polarity: (+) to (+) and (-) to (-).
- 3 Close the speaker terminals.

IMPORTANT: Use only speakers with the same speaker impedance as indicated by the speaker terminals on the rear of the unit.



- DO NOT connect more than one speaker to each speaker terminal.
- DO NOT push or pull the speakers as this will damage the foot spacers at the bottom of the speakers.



Connecting Other Equipment

You can connect both analog and digital equipment.



- DO NOT connect any equipment while the power is on.
- DO NOT plug in any equipment until all connections are complete.

To connect an analog component

Be sure that the plugs of the audio cords are colored: White plugs and jacks are for left audio signals, and red ones for right audio signals.

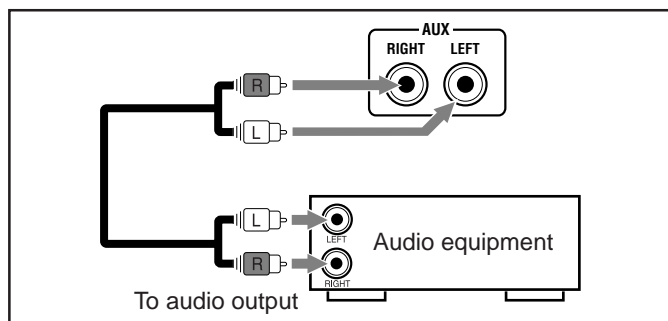

For playing the other equipment through this unit, connect between the audio output jacks on the other equipment and AUX jacks by using audio cords (not supplied).

To connect audio equipment with an optical digital input terminal

You can record CD sound onto the connected digital equipment.

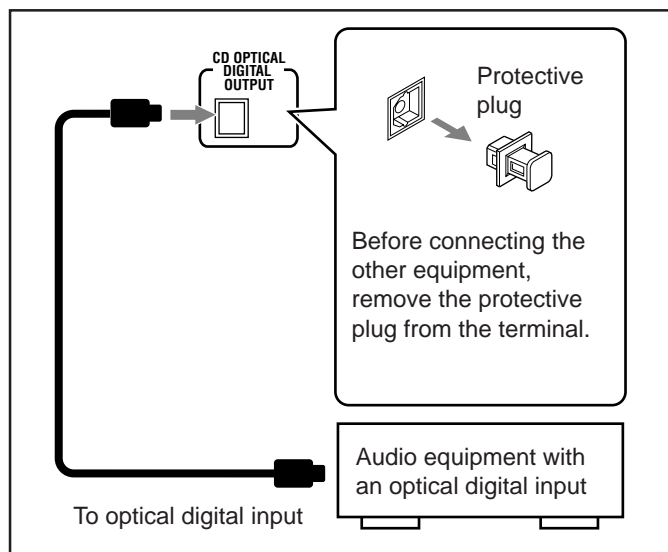

Connect an optical digital cord (not supplied) between the optical digital input terminal on the other equipment and the CD OPTICAL DIGITAL OUTPUT terminal.

Now, you can plug the AC power cord.

IMPORTANT: Be sure to check all connections to be done before plugging the AC power cord into a wall outlet.

Canceling the Demonstration

When connecting the AC power cord into a wall outlet, the unit automatically starts the demonstration.

To cancel the demonstration, press and hold CANCEL/DEMO until "DEMO OFF" appears on the display.



- To cancel only beep sounds during the demonstration, press BEEP ON/OFF on the remote control.



When you press other buttons



The demonstration stops temporarily. It will start automatically again (if no operation is done for 2 minutes) unless you cancel it by pressing CANCEL/DEMO.

To start the demonstration manually

Press and hold CANCEL/DEMO again until "DEMO START" appears on the display.



Common Operations

Turning On or Off the Power

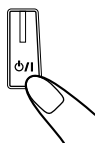
To turn on the unit, press  (or STANDBY/ON  on the remote control) so that the lamp on the button goes off.



POWER ON

To turn off the unit (on standby), press  (or STANDBY/ON  on the remote control) again so that the lamp on the button lights up.

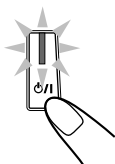

- A little power is always consumed even while the unit is on standby.

To switch off the power supply completely, unplug the AC power cord from the AC outlet.



notes When you unplug the AC power cord or if a power failure occurs

The clock is reset to “AM 12:00” right away, while the tuner preset stations (see page 12) will be erased in a few days.

Saving the Power Consumption while on Standby —Ecology Mode

You can save the power consumption while the unit is turned off (on standby).

- You can set Ecology Mode whether the unit is on or off.

On the unit ONLY:

To activate the Ecology Mode, press ECO. “ECO” appears on the display for 2 seconds (and demonstration is canceled temporarily if you have pressed the button while the unit is off).



- Each time you press the button, “ECO” and “NORMAL” appear alternately on the display.

To deactivate the Ecology Mode, press ECO again. “NORMAL” appears (and demonstration starts if the unit is turned off).



notes When you turn off the unit with Ecology Mode activated “ECO” flashes on the display, and the clock time will not be shown while the unit is turned off.

Setting the Clock

You can set the clock whether the unit is on or off; however, if Ecology Mode is activated, you cannot set the clock while the unit is off. “AM 12:00” flashes on the display until you set the clock.

On the unit ONLY:

1 Press CLOCK/TIMER.

The hour digits start flashing on the display.

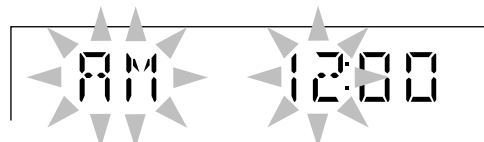
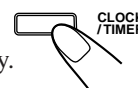

2 Turn / to adjust the hour, then press SET/DISPLAY.

The minute digits start flashing on the display.

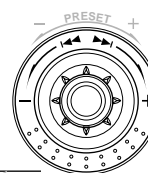

If you want to correct the hour after pressing SET/DISPLAY, press CANCEL/DEMO. The hour digits start flashing again.

CANCEL / DEMO

SET / DISPLAY

3 Turn / to adjust the minute, then press SET/DISPLAY.

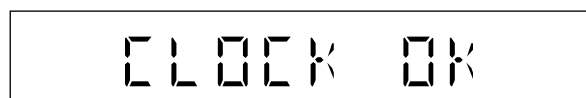

To check the clock time

Press and hold SET/DISPLAY while playing any source.

- Each time you press and hold the button, the source indication and the clock time alternate on the display.

To adjust the clock again

If you have set the clock before, you need to press CLOCK/TIMER repeatedly until the clock setting mode is selected.

- Each time you press the button, the clock/timer setting modes change as follows:

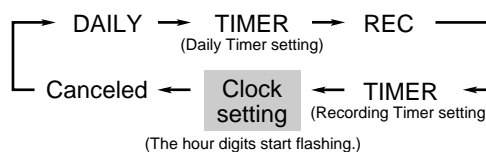

notes When you unplug the AC power cord or if a power failure occurs

The clock loses the setting and is reset to “AM 12:00.” You need to set the clock again.

Selecting the Sources

To listen to the FM/AM broadcasts, press FM/AM.

(See page 12.)

To play back CDs, press CD ►/II. (See pages 13 – 17.)

To play back tapes, press TAPE ◀▶. (See page 18.)

To select the external equipment as the source, press AUX.



When you press the play button for a particular source (FM/AM, CD ►/II, TAPE ◀▶, and AUX), the unit turns on and the unit starts playing the source if it is ready.

Adjusting the Volume

You can adjust the volume level only while the unit is turned on. The volume level can be adjusted in 32 steps (VOLUME MIN, VOLUME 1 – VOLUME 30, and VOLUME MAX).

Turn VOLUME + / – clockwise (+) to increase the volume or counterclockwise (–) to decrease it.

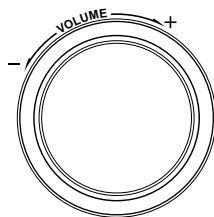

When using the remote control, press VOLUME + to increase the volume or VOLUME – to decrease it.



For private listening

Connect a pair of headphones to the PHONES (🎧) jack. No sound comes out of the speakers. Be sure to turn down the volume before connecting or putting on headphones.



DO NOT turn off (on standby) the unit with the volume set to an extremely high level; otherwise, a sudden blast of sound can damage your hearing, speakers and/or headphones when you turn on the unit or start playing any source next time. REMEMBER you cannot adjust the volume level while the unit is on standby.

To turn down the volume level temporarily

On the remote control ONLY:

Press FADE MUTING.

The volume level gradually decreases to “VOLUME MIN.”



To restore the sound, press the button again.

Reinforcing the Bass Sound

You can select one of the 5 subwoofer levels. This function only affects the playback sound, but does not affect your recording. The subwoofer level can be adjusted in 5 steps—LEVEL 0 (MIN LEVEL), LEVEL 1, LEVEL 2, LEVEL 3, and LEVEL 4 (MAX LEVEL).

Press SUBWOOFER LEVEL + to increase the subwoofer level or SUBWOOFER LEVEL – to decrease it.



SUBWOOFER lamp lights up in red

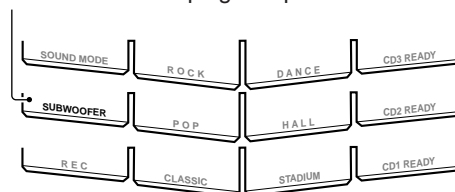

- The SUBWOOFER lamp lights up in red when LEVEL 1 to LEVEL 4 (MAX LEVEL) is selected. The lamp lights off when LEVEL 0 (MIN LEVEL) is selected.

Selecting the Sound Modes

You can select one of the 6 preset sound modes (3 surround modes and 3 SEA—Sound Effect Amplifier—modes) and 3 user modes. This function only affects the playback sound, but does not affect your recording. Each Sound Mode has its own display illumination.

To select the sound modes, turn SOUND MODE (or press SOUND MODE on the remote control) until the sound mode you want appears on the display.

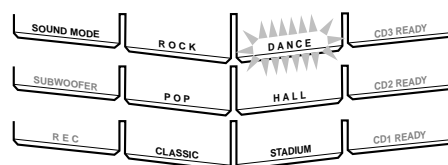
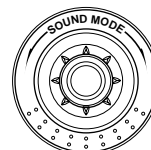

- When a sound mode is selected (for this example DANCE), the SOUND MODE lamp and other than the selected sound mode lamps light up. While the selected sound mode lamp flashes. (If USER 1, USER 2, and USER 3 is selected, only the SOUND MODE lamp lights up. If OFF is selected, the SOUND MODE lamp and other sound mode lamps go off.)

The sound modes change as follows:

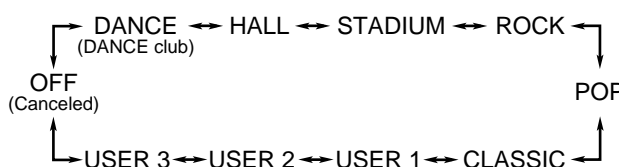

When using the remote control, the sound mode changes clockwise in the above sequence.

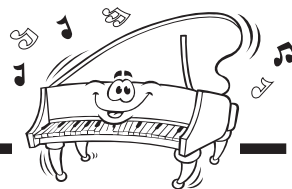

Surround modes*

- DANCE:** Increases resonance and bass.
HALL: Adds depth and brilliance to the sound.
STADIUM: Adds clarity and spreads the sound, like in an outdoor stadium.

SEA (Sound Effect Amplifier) modes

- ROCK:** Boosts low and high frequency. Good for acoustic music.
POP: Good for vocal music.
CLASSIC: Good for classical music.

User Modes

USER 1/2/3: Your individual mode stored in memory. See “Creating Your Own Sound Mode—User Mode” below.

OFF: The sound mode is canceled.

* Surround elements are added to the SEA elements to create a being-there feeling in your room.

Creating Your Own Sound Mode—User Mode

You can change SEA pattern to suit your preference. The SEA pattern can be adjusted into 5 frequency range—LOW1, LOW2, MID, HIGH1, and HIGH2. These changed settings can be stored in the USER 1, USER 2, and USER 3 modes.

- There is a time limit in doing the following steps. If the setting is canceled before you finish, start from step 1 again.

On the unit ONLY:

1 Select one of the preset sound modes.

- If you want to add the surround elements in your SEA pattern, select one of the surround modes (DANCE, HALL, or STADIUM) before starting the procedure below. (See “Selecting the Sound Modes” on page 10.)

2 Press SET/DISPLAY while the selected sound mode is still shown on the display.

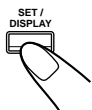

SEA CONT



LOW 1 +3

Current level appears.

3 Adjust the SEA pattern.

- 1) Turn |◀◀ / ▶▶| to select the frequency range (LOW1, LOW2, MID, HIGH1, and HIGH2).

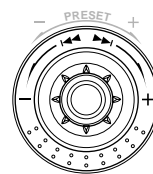

- 2) Press ◀◀ or ▶▶ to adjust the level (-3 to +3) of the selected frequency range.

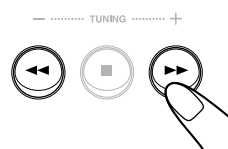

- 3) Repeat steps 1) and 2) to adjust the level of the other frequency ranges.

4 Press SET/DISPLAY again.

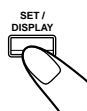

USER 1

5 Turn |◀◀ / ▶▶| to select one of the user modes (USER 1, USER 2, and USER 3) which you want to store the SEA pattern.

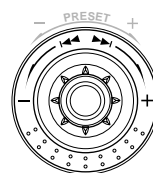

6 Press SET/DISPLAY again.

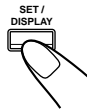

MEMORY

The SEA pattern you have created are stored into the user mode selected in the above step.

To use your own sound mode

Select USER 1, USER 2, or USER 3 mode when using the sound modes. See “Selecting the Sound Modes” on page 10.



notes When you unplug the AC power cord or if a power failure occurs

The setting will be erased in a few days. If this happens, set the user modes again.

Turning On or Off the Key-touch Tone

If you do not want the key-touch tone to beep each time you press a button, you can deactivate it.

On the remote control ONLY:

Press BEEP ON/OFF.

- Each time you press the button, the key-touch tone turns on and off alternately.





Listening to FM and AM Broadcasts

Tuning in to a Station

1 Press FM/AM.

The unit automatically turns on and tunes in to the previously tuned station (either FM or AM).

- Each time you press the button, the band alternates between FM and AM.

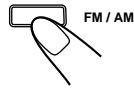

2 Start searching for stations.

On the unit:

Press and hold TUNING + or TUNING - for more than 1 second.

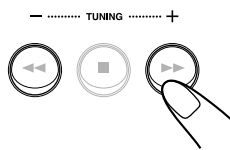

On the remote control:

Press and hold >>> (right arrow) or <<< (left arrow) for more than 1 second.

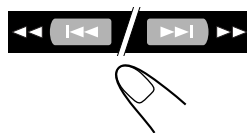

The unit starts searching for stations and stops when a station of sufficient signal strength is tuned in.

- If a program is broadcast in stereo, the ST (stereo) indicator lights up.

To stop searching, press TUNING + or TUNING - (or >>> / <<< on the remote control).



When you press TUNING + or TUNING - (or >>> / <<< on the remote control) briefly and repeatedly the frequency changes step by step.

To change the FM reception mode

On the remote control ONLY:

When an FM stereo broadcast is hard to receive or noisy, press FM MODE so that the MONO indicator lights up on the display. Reception improves.

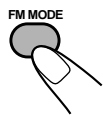

To restore the stereo effect, press FM MODE again so that the MONO indicator goes off. In this stereo mode, you can hear stereo sounds when a program is broadcasted.

Presetting Stations

You can preset 30 FM and 15 AM stations.

In some cases, test frequencies have been already memorized for the tuner since the factory examined the tuner preset function before shipment. This is not a malfunction. You can preset the stations you want into memory by following the presetting method.

- There is a time limit in doing the following steps. If the setting is canceled before you finish, start from step 2 again.

On the unit ONLY:

1 Tune in to the station you want to preset.

- See "Tuning in to a Station."

2 Press SET/DISPLAY.

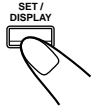
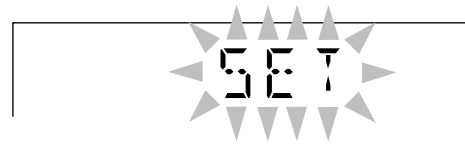

3 Turn PRESET + / - to select a preset number.

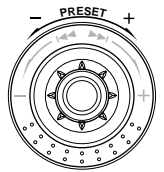
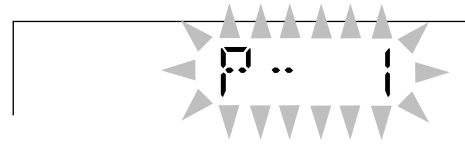

4 Press SET/DISPLAY again.

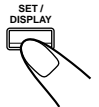
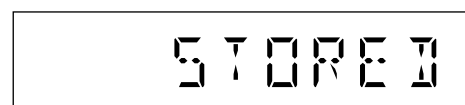

The tuned station in step 1 is stored in the preset number selected in step 3.

- Storing a new station on a used number erases the previously stored one.



When you unplug the AC power cord or if a power failure occurs

The preset stations will be erased in a few days. If this happens, preset the stations again.

Tuning in to a Preset Station

1 Press FM/AM.

The unit automatically turns on and tunes in to the previously tuned station (either FM or AM).

- Each time you press the button, the band alternates between FM and AM.



2 Select a preset number.

On the unit:

Turn PRESET + / -.

On the remote control:

Press the number buttons.

Ex.: For preset number 5, press 5.

For preset number 15, press +10, then 5.

For preset number 25, press +10, +10, then 5.

For preset number 30, press +10, +10, then 10.

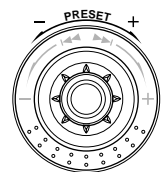
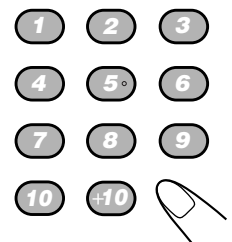

Playing Back CDs (CD/CD-R/CD-RW)

This unit has been designed to playback the following CDs:

- CD (Audio CD)
- CD-R (CD-Recordable)
- CD-RW (CD-ReWritable)

Continued use of irregular shape CDs (heart-shape, octagonal, etc.) can damage the unit.

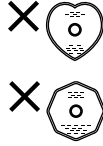

When playing a CD-R or CD-RW

User-edited CD-Rs (CD-Recordable) and CD-RWs (CD-ReWritable) can be played back only if they are already “finalized.”

- You can play back your original CD-Rs or CD-RWs recorded in music CD format. (However, they may not be played back depending on their characteristics or recording conditions.)
- Before playing back CD-Rs or CD-RWs, read their instructions or cautions carefully.
- Some CD-Rs or CD-RWs may not be played back on this unit because of their disc characteristics, damage or stain on them, or the player’s lens is dirty.
- CD-RWs may require a longer readout time. This is caused by the fact that the reflectance of CD-RWs is lower than for regular CDs.

Loading CDs

On the unit ONLY:

- 1** Press  for the disc tray (CD1, CD2, and CD3) you want to load a CD onto.

The unit automatically turns on and the disc tray comes out.

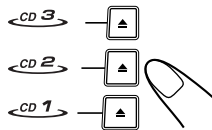

- 2** Place a disc correctly on the circle of the disc tray, with its label side up.

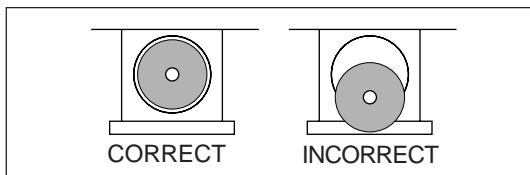

- When using a CD single (8 cm), place it on the inner circle of the disc tray.

- 3** Press the same  you have pressed in step 1.

The disc tray closes.

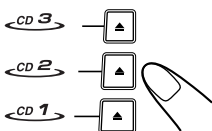

- 4** Repeat steps 1 to 3 to place other CDs.



When loading more than one CD continuously

When you press  for the next tray you want to place another CD onto, the first disc tray automatically closes and then the next tray comes out.

About the CD ready lamps

Each CD ready lamp corresponds to the disc tray of the same number.

• When and why they light up?

- When you turn on the unit for the first time after plugging into a wall outlet, all CD ready lamps (CD1 READY, CD2 READY, and CD3 READY) lights up. From the next time on, CD ready lamp(s) light(s) up according to the previous condition.
- Each time you press the CD eject buttons— (CD1, CD2, and CD3), the corresponding CD ready lamp lights up.

• When and why they go off?

- Only when the unit detects there is no CD loaded on the tray, the corresponding CD ready lamp goes off. (“NO DISC 1,” “NO DISC 2,” or “NO DISC 3” appears on the display.)

• When and why they flash?

- The corresponding CD ready lamp flashes during playback and pause.

Playing Back the Entire Discs—Continuous Play

You can play CDs continuously.

1 Load CDs.

2 Press one of the disc number (CD1, CD2, and CD3) buttons for the disc you want to play.

The unit starts searching for the CD and CD play starts from the first track of the selected disc.

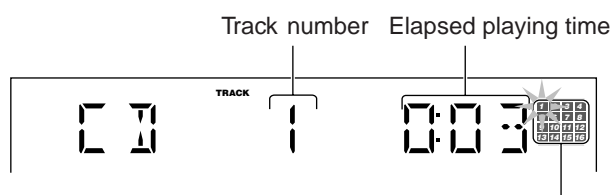
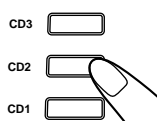

Tracks of the currently playing disc (Track numbers exceeding 16 are not displayed.)

- Pressing CD ►/|| instead of the disc number buttons starts playing back the currently selected CD.
- If no CD is placed on the selected disc tray, “NO DISC 1,” “NO DISC 2,” or “NO DISC 3” appears on the display. Then, the unit continue searching for a CD from the next disc tray.

To stop playing, press ■.

To remove the disc, press ▲ for the corresponding disc tray.



CD playback sequence

When 3 CDs* are loaded on the disc trays, they are played in one of the following sequences.

- When CD1 is pressed: CD1 ⇒ CD2 ⇒ CD3 (then stops)
- When CD2 is pressed: CD2 ⇒ CD3 ⇒ CD1 (then stops)
- When CD3 is pressed: CD3 ⇒ CD1 ⇒ CD2 (then stops)

* When only 2 CDs are loaded, they are played in the same order, but the disc tray without a CD is skipped.

Basic CD Operations

While playing a CD, you can do the following operations.

To exchange CDs during playback of another

Press ▲ corresponding to a CD, not playing or selected currently, to eject and exchange the CD.

If you exchange CDs during play, the current play will not stop until all CDs you have exchanged are played.

To stop play for a moment

Press CD ►/||.

While pausing, the elapsed playing time flashes on the display.

To resume playing, press CD ►/|| again.

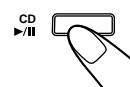

To go to another track

Turn ◀◀◀ / ▶▶▶ before or during playback (or press ◀◀◀ (◀◀◀) / ▶▶▶ (▶▶▶) on the remote control).

- ◀◀◀ (or ◀◀◀ (◀◀◀)): Goes back to the beginning of the current or previous tracks.
- ▶▶▶ (or ▶▶▶ (▶▶▶)): Skips to the beginning of the next or succeeding tracks.

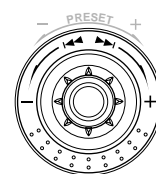

To locate a particular point in a track

During play, press and hold ◀◀ or ▶▶ (or ◀◀◀ (◀◀◀) / ▶▶▶ (▶▶▶) on the remote control).

- ◀◀ (or ◀◀◀ (◀◀◀)): Fast reverses the disc.
- ▶▶ (or ▶▶▶ (▶▶▶)): Fast forwards the disc.

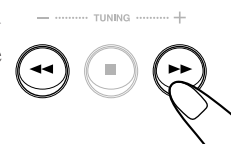

To go to another track directly using the number buttons

On the remote control ONLY:

Pressing the number button(s) before or during play allows you to start playing the track number you want.

Ex.: For track number 5, press 5.

For track number 15, press +10, then 5.

For track number 20, press +10, then 10.

For track number 32, press +10, +10, +10, then 2.

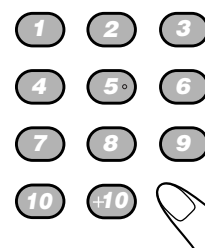

Programming the Playing Order of the Tracks —Program Play

You can arrange the playing order of the tracks before you start playing. **You can program up to 32 tracks.**

- To use Repeat Play (see page 17) for Program Play, press REPEAT after starting Program Play. Only REPEAT 1 and REPEAT ALL can be selected for Program Play.
- There is a time limit in doing the following steps. If the setting is canceled before you finish, start from step 2 again.

1 Load CDs.

- If the current playing source is not the CD player, press CD ►/II, then ■ before going to the next step.

2 Activating the Program Play mode.

On the unit:

Press CD PLAY MODE repeatedly until “CD PROGRAM” appears on the display.

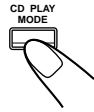

- Each time you press the button, the play mode changes as follows:

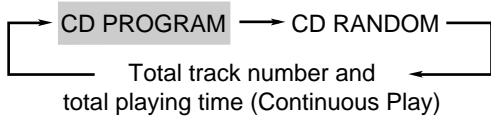

On the remote control:

Press PROGRAM so that “CD PROGRAM” appears on the display.

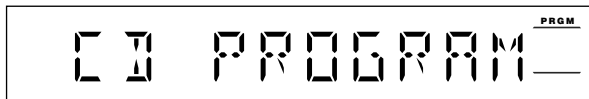

- If a program has been stored in memory, the program is called up.
- The PRGM (program) indicator also lights up on the display.

3 Press one of the disc number (CD1, CD2, and CD3) buttons to select the disc you want to play.

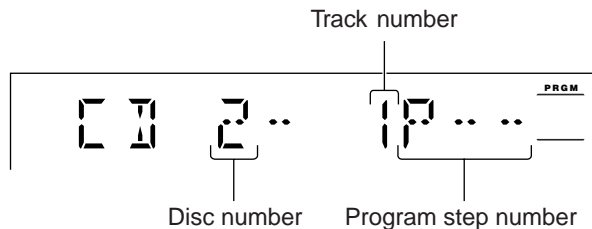
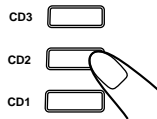

4 Select a track from the selected CD in the above step.

On the unit:

Turn ◀◀ / ▶▶ to select the track number and press SET/DISPLAY.

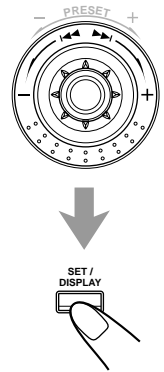

On the remote control:

Press the number buttons.

- For how to use the number buttons, see “To go to another track directly using the number buttons” on page 14.

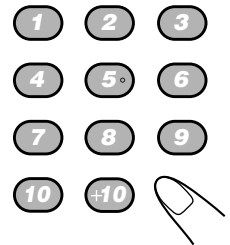

5 Program other tracks you want.

- To program tracks from the same disc, repeat step 4.
- To program tracks from a different disc, repeat steps 3 and 4.

6 Press CD ►/II.

The tracks are played in the order you have programmed.

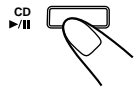

To stop playing, press ■.

To exit from Program Play mode, press CD PLAY MODE repeatedly (or PROGRAM on the remote control) until the PRGM (program) indicator goes off. The program you have made is stored in memory.



- **If you try to program a 33rd track**
“CD FULL” will appear on the display.
- **If your entry is ignored**
You have tried to program a track from an empty tray, or a track number that does not exist on the CD (for example, selecting track 14 on a CD that only has 12 tracks). Such entries are ignored.

To check the program contents

On the remote control ONLY:

Before playing, you can check the program contents by pressing

◀◀ (◀◀) or ▶▶ (▶▶).

- ◀◀ (◀◀): Shows the programmed tracks in the reverse order.
- ▶▶ (▶▶): Shows them in the programmed order.

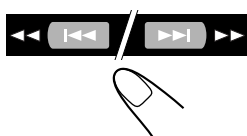

To modify the program

Before or after playing, you can erase the last programmed tracks by pressing CANCEL/DEMO (or press PROGRAM CANCEL on the remote control).

- Each time you press the button, the last programmed track is erased from the program.

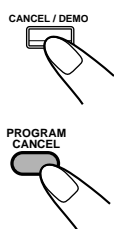

To add tracks in the program before playing, simply select the track numbers you want to add by following step 4 of the programming procedure on page 15. If you want to add tracks from another disc, follow steps 3 and 4.

To erase the entire program before or after playing, press and hold ■ until “CD PROGRAM” appears on the display.

- The program you have made will be erased,
 - when you unplug the AC power cord, and
 - when a power failure occurs.

Playing at Random—Random Play

The tracks of all loaded CDs will be played at random.

- To use Repeat Play (see page 17) for Random Play, press REPEAT after starting Random Play. Only REPEAT 1 and REPEAT ALL can be selected for Random Play.

1 Load CDs.

- If the current playing source is not the CD player, press CD ▶/■, then ■ before going to the next step.

2 Activating the Random Play mode.

On the unit:

Press CD PLAY MODE repeatedly until “CD RANDOM” appears on the display.

- Each time you press the button, the play mode changes as follows:

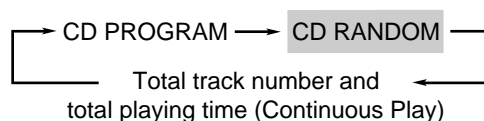

On the remote control:

Press RANDOM so that “CD RANDOM” appears on the display.

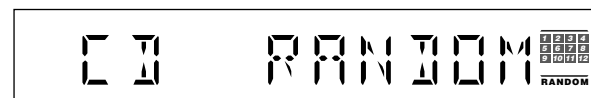

- The RANDOM indicator also lights up on the display.

3 Press CD ▶/■.

The tracks are randomly played.

Random Play ends when all the tracks are played once.



To skip the currently playing track, turn ◀◀ / ▶▶ to the right (or press ▶▶ (▶▶) on the remote control).



If you turn ◀◀ / ▶▶ to the left (or press ◀◀ (◀◀) on the remote control)

- You cannot go back to the previous tracks during Random Play.
- You can only restart the current playing track.

To stop playing, press ■.

- Random play also stops when one of the disc trays is opened.

To exit from Random Play mode, press CD PLAY MODE (or RANDOM on the remote control) repeatedly, until the RANDOM indicator goes off after playback stops.



Repeating Tracks or CDs—Repeat Play

You can have all the CDs, the program or the individual track currently playing to repeat as many times as you like.

To repeat playing, press REPEAT during or before play.

- Each time you press the button, Repeat Play mode changes as follows:

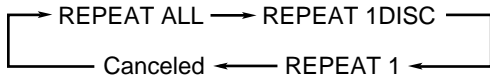

The Repeat Play mode indicator lights up on the display.

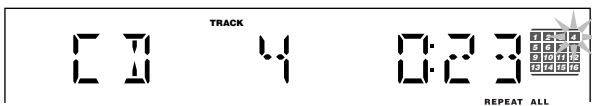

REPEAT ALL: Repeats all the tracks on all the CDs (continuously or at random), or all the tracks in the program.

REPEAT 1DISC: Repeats all the tracks on one CD.

REPEAT 1: Repeats one track on one CD.

To cancel Repeat Play, press REPEAT repeatedly until the Repeat Play mode indicators go off from the display.



“REPEAT 1DISC” is not selected for Program Play and Random Play

It is canceled when you select Program Play or Random Play.

Prohibiting Disc Ejection—Tray Lock

You can prohibit CD ejection from the unit and lock CDs.

- This operation is possible only when the source is the CD player.

On the unit ONLY:

To prohibit disc ejection, press ▲ for any disc tray while holding down ■. (If there is any disc tray opened, close it first.)

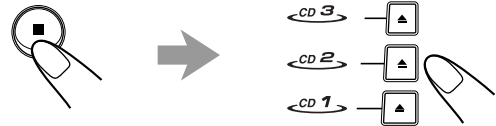

“LOCKED” appears for a while on the display, and the loaded CDs are locked.

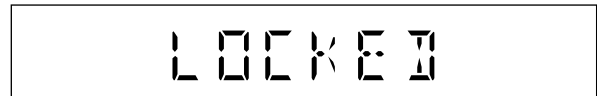

To cancel the prohibition and unlock the CDs, press ▲ for any disc tray while holding down ■.

“UNLOCKED” appears for a while on the display, and the loaded CDs are unlocked.



If you try to eject CDs while Tray Lock is in used “LOCKED” appears to inform you that the disc tray is locked.

Playing Back Tapes

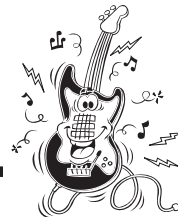

You can play back type I tapes without changing any settings.

Playing Back a Tape

1 Press **EJECT** for the cassette deck.

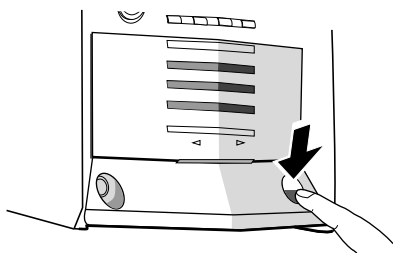

2 Put a cassette in with the exposed part of the tape down.

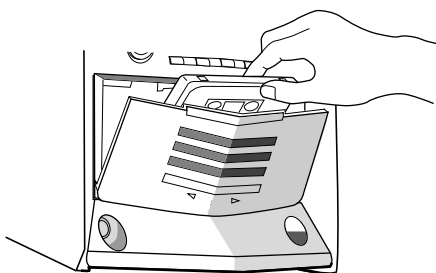

3 Close the cassette holder gently.

4 Press **TAPE** **◀▶**.

The tape play starts and the tape direction indicator (▶ or ◀) starts flashing slowly to indicate the tape running direction.

• Each time you press the button, the tape direction changes and “REVERSE” appears for a while on the display.

- ▶ : plays the front side.
- ◀ : plays the reverse side.

• If no cassette is inserted, “NO TAPE” appears on the display.

When the tape plays to the end, the deck automatically stops if the Reverse Mode is off. (See “To play both sides repeatedly—Reverse Mode.”)

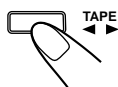

To stop playing, press ■.

To fast-wind to the left or to the right, press ◀▶ or ◀◀▶▶ (or ◀◀◀ (◀◀◀) / ▶▶▶ (▶▶▶) on the remote control) while the tape is not running.

The tape direction indicator (▶ or ◀) starts flashing quickly on the display.

To remove the cassette, press ▲ EJECT to open the cassette holder.



The use of the C-120 or thinner tape is not recommended, since characteristic deterioration may occur and this tape easily jams in the pinch-rollers and the capstans.

To play both sides repeatedly—Reverse Mode

When using Reverse Mode, the tape automatically reverses at the end of a side and the unit starts playing for the other side of the tape, and repeats the same process.

On the unit ONLY:

To use Reverse Mode, press REVERSE MODE so that the Reverse Mode indicator on the display lights up like—(Z).

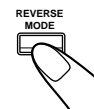

To cancel Reverse Mode, press the button again so that the Reverse Mode indicator on the display lights up like—Z.

Locating the Beginning of a Song—Music Scan

You can use Music Scan to locate the beginning of a song. Music Scan searches for blank portions that usually separate recorded songs, then plays the next song.

To find the beginning of the current song

During play, press ◀▶ or ▶▶ (or ◀◀◀ (◀◀◀) / ▶▶▶ (▶▶▶) on the remote control) in the **opposite direction** to the tape play.

The tape direction indicator of the opposite direction to the tape play starts flashing intermittently.

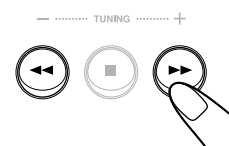

Searching stops automatically at the beginning of the current song, and the current song starts automatically.

To find the beginning of the next song

During play, press ◀▶ or ▶▶ (or ◀◀◀ (◀◀◀) / ▶▶▶ (▶▶▶) on the remote control) in the **same direction** as the tape play.

The tape direction indicator of the same direction as the tape play starts flashing intermittently.

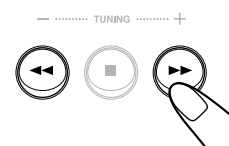

Searching stops automatically at the beginning of the next song, and the next song starts automatically.



Music Scan works by detecting a 4-second long blank between each song, so it will not work well in the following cases

- No blank at the beginning of a song.
- Noise (often caused by much use or poor quality dubbing) which fills the blank.
- Long, very soft passages or pauses in a song.

Recording

IMPORTANT:

- It should be noted that it may be unlawful to re-record pre-recorded tapes, records, or discs without the consent of the owner of copyright in the sound or video recording, broadcast or cable programme and in any literary, dramatic, musical, or artistic embodied therein.
- The recording level is automatically set correctly, so it is not affected by the VOLUME, the SUBWOOFER LEVEL, and the SOUND MODE controls. Thus, during recording you can adjust the sound you are actually listening to without affecting the recording level.
- If there are excessive noise or static in the recording you have made, the unit may be too close to a TV. Increase the distance between the TV and the unit.
- You can use type I tape for recording.

To protect your recording

Cassettes have two small tabs on the back to protect from unexpected erasure or re-recording.

To protect your recording, remove these tabs.

To re-record on a protected tape, cover the holes with adhesive tape.

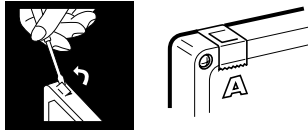

To keep the best recording and playback sound quality

If the heads, capstans, and pinch rollers of the cassette deck become dirty, the following will occur:

- Impaired sound quality
- Discontinuous sound
- Fading
- Incomplete erasure
- Difficulty in recording

To clean the heads, capstans, and pinch rollers

Use a cotton swab moistened with alcohol.

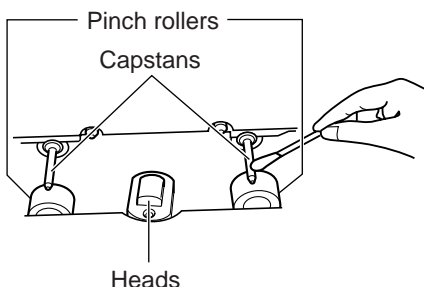

To demagnetize the heads

Turn off the unit, and use a head demagnetizer (available at electronics and audio shops).

Recording on a Tape

- 1 Press **▲ EJECT** to insert a recordable cassette with the exposed part of the tape down.

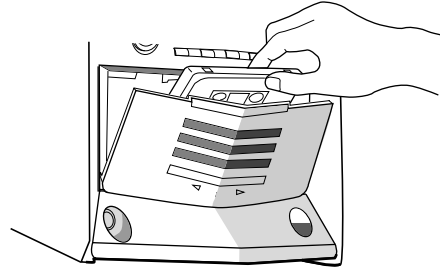

- 2 Close the cassette holder gently.
 - If you want to record on both sides of a tape, see “To record on both sides—Reverse Mode.”
- 3 Check the tape direction of the cassette deck.
 - If the tape direction is not correct, press TAPE ◀▶ twice then ■ to change the tape direction.
- 4 Start playing the source—FM, AM, CD player, or auxiliary equipment connected to AUX jacks.
 - When the source is CD, you can also use CD Direct Recording—(see page 20), and Auto Edit Recording—(see page 21).

- 5 Start recording.

On the unit:

Press **REC START/STOP**.

On the remote control:

Press and hold **REC START/STOP** for more than 1 second.

The REC (recording) lamp flashes when recording starts and the tape direction indicator (▶ or ◀) starts flashing slowly.

- If no cassette is inserted, “NO TAPE” appears on the display. If a protected tape is inserted, “NO REC” appears on the display.

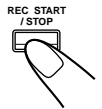

To stop recording immediately, press **REC START/STOP** or ■ (or press and hold **REC START/STOP** on the remote control for more than 1 second).

To remove the cassette, press **▲ EJECT** to open the cassette holder.

To record on both sides—Reverse Mode

On the unit ONLY:

Press **REVERSE MODE** so that the Reverse Mode indicator on the display lights up like—(Z).

- When using the Reverse Mode for recording, start recording in the forward (▶) direction first. Otherwise, recording will stop when recording is done only on one side (reverse) of the tape.

To cancel Reverse Mode, press the button again so that the Reverse Mode indicator on the display lights up like—Z.

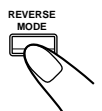

CD Synchronized Recording

By using CD Synchronized Recording methods, you can start and stop a CD play and tape recording at the same time. CD Synchronized Recording consists of the followings:

- CD Direct Recording
- Auto Edit Recording

■ CD Direct Recording

Everything on the CD goes onto the tape in the order it is on the CD, or according to the order you have made for Program Play.

On the unit ONLY:

- 1** Press  **EJECT** to insert a recordable cassette in with the expose part of the tape down.



- 2** Load CDs.

- 3** Press one of the disc number (CD1, CD2, and CD3) buttons to select the disc, then .

- If you want to make a program, perform steps **2** to **5** on page 15. After making a program, go to the next step.

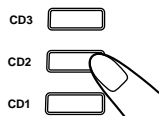



- 4** Press **CD REC START**.

“CD REC” appears on the display and the REC (recording) lamp flashes when recording starts.

The cassette deck starts recording while the CD player starts playing.

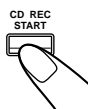
When the recording is done, “CD REC FINISHED” scroll through the display, and the REC (recording) lamp goes off. Both the cassette deck and the CD player stop automatically.



To stop recording, press  to create a 4-second blank portion on the recording tape. (Remember a 4-second blank is important when using Music Scan—see page 18.)





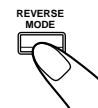

To record on both sides—Reverse Mode

On the unit ONLY:

Press REVERSE MODE so that the Reverse Mode indicator on the display lights up like—.



- When using the Reverse Mode for CD Direct Recording, start recording in the forward () direction first. When the tape reaches its end while recording a song in the forward direction () , the last song will be re-recorded at the beginning of the reverse side () . If you start recording on the reverse side () , recording will stop when recording is done only on one side (reverse) of the tape.

To cancel Reverse Mode, press the button again so that the Reverse Mode indicator on the display lights up like—.



■ Auto Edit Recording

By using Auto Edit Recording, you can record the CD tracks to fit the tape. Auto Edit Recording makes a program by selecting the CD tracks in numerical order. However, to prevent the end of the last track on the front side from being cut off, the last track is selected so to fit the remaining tape length.

On the unit ONLY:

1 Load CDs.

- If the current playing source is not the CD player, press CD ►/||, then ■ before going to the next step.

2 Press EDIT.

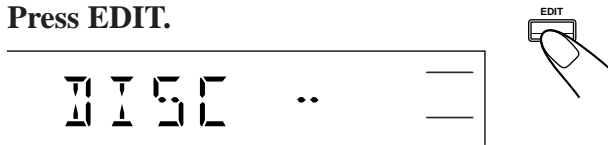

3 Press one of the disc number (CD1, CD2, and CD3) buttons to select the disc you want to record from.

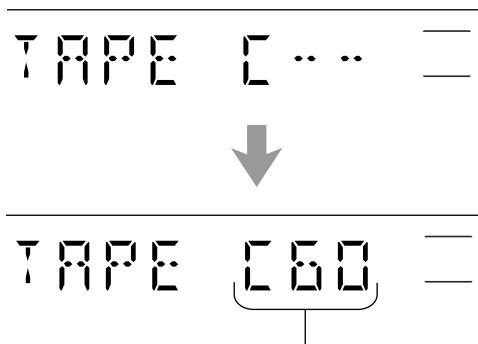
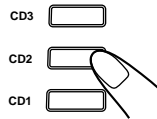

The optimum tape length for the disc appears.

To change the tape length manually

If the tape length selected is not satisfactory, you can change the tape length by turning |◀◀/▶▶| on the unit. You can select the tape length among the following—40, 46, 50, 54, 60, 64, 70, 74, 80, 84, and 90.

4 Press SET/DISPLAY.

- Each time you press the button, the tracks to be recorded on the front side (“SIDE-A”) and on the reverse side (“SIDE-B”) appears on the display alternately.

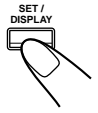

Tracks to be recorded on the reverse side (SIDE-B) appear.

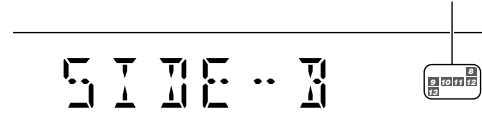

5 Put a recordable cassette of appropriate length into the cassette deck.

6 Press REVERSE MODE so that the Reverse Mode indicator lights up like (Z).

- Without turning on the Reverse Mode, recording will stop when the front side of the tape is recorded.

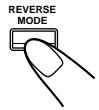

7 Press CD REC START.

“CD REC” appears, then “TAPE SIDE-A STAND-BY” scroll through the display, and the REC (recording) lamp flashes.

The cassette deck starts recording. About 10 seconds later, the CD player starts playing.

When the recording is done, “CD REC FINISHED” scroll through the display and the REC (recording) lamp goes off. Both the cassette deck and CD player stop automatically.

- If a tape has not been rewound, the cassette deck will rewind the tape before it starts recording.
- A 10-second blank portion is automatically created at the beginning of each side of the tape.

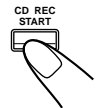

To stop during Auto Edit Recording

Press REC START/STOP or ■ to create a 4-second blank portion on the recording tape. (Remember a 4-second blank is important when using Music Scan—see page 18.)

To cancel Auto Edit Recording

Press CANCEL/DEMO before or after recording.

There are three timers available—DAILY (Daily Timer), REC (Recording Timer), and SLEEP (Sleep Timer).

Before using the timers, you need to set the clock built in the unit. (See page 9.)

Using Daily Timer

With Daily Timer, you can be awakened with your favorite music or radio program.

You can set the timer whether the unit is on or off; however, if Ecology Mode is activated, you cannot set the clock while the unit is off.

How Daily Timer actually works

The unit automatically turns on, sets the volume level to the preset level, and starts playing the specified source when the on-time comes (“DAILY” and the DAILY (Daily Timer) indicator flash just before the on-time, and the DAILY (Daily Timer) indicator continues flashing while the timer is operating). Then, when the off-time comes (“DAILY OFF” flashes just before the off-time), the unit automatically turns off (on standby).

The Daily Timer works everyday automatically. If you do not want to use the Daily Timer, turn off the Daily timer. (See “To turn on or off Daily Timer after its setting is done” on page 23.) The timer setting remains in memory until you change it.

- There is a time limit in doing the following steps. If the setting is canceled before you finish, start from step 1 again.
- To correct a mis-entry while setting the timer, press CANCEL/DEMO.

Before you start...

- *When using a CD as the source to play—*
 - Make sure there is a CD on the selected disc number tray.
- *When using a tape as the source to play—*
 - Make sure that a tape is in the cassette deck.
 - Make sure that the tape direction is correct.
- *When using the external component as the source to play—*
 - Set the timer equipped on the external component at the same time.

On the unit ONLY:

- 1 Press **CLOCK/TIMER** repeatedly until “DAILY” appears on the display.

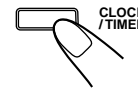

(Timer) indicator lights up and the DAILY (Daily Timer) indicator also starts flashing on the display.



- Each time you press the button, the timer setting modes change as follows:

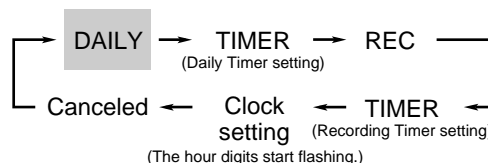

- 2 Press **CLOCK/TIMER** again.

“TIMER” appears for 2 seconds, then the unit enters on-time setting mode.

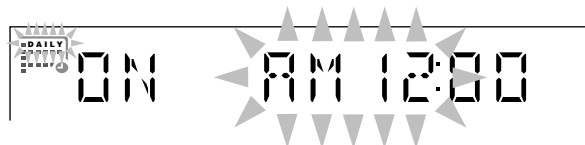
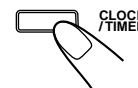

- 3 Set the on-time you want the unit to turn on at.

1) Turn **◀◀ / ▶▶** to set the hour, then press **SET/DISPLAY**.

“SET” appears for 1 second.

2) Turn **◀◀ / ▶▶** to set the minute, then press **SET/DISPLAY**.

“SET” appears for 1 second, then

the unit enters off-time setting mode.

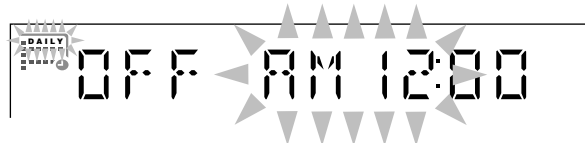
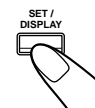
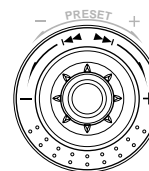

4 Set the off-time you want the unit to turn off (on standby) at.

- 1) Turn **◀◀ / ▶▶** to set the hour, then press **SET/DISPLAY**.
“SET” appears for 1 second.
- 2) Turn **◀◀ / ▶▶** to set the minute, then press **SET/DISPLAY**.
“SET” appears for 1 second, then the unit enters source selecting mode.

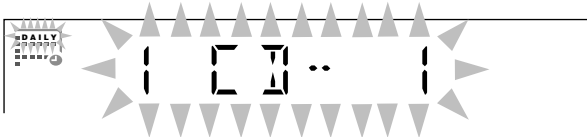

5 Turn **◀◀ / ▶▶** to select the source to play, then press **SET/DISPLAY**.

- “SET” appears for 1 second.
- The source changes as follows:



TUNER FM: tunes into a specified preset FM station.

→ Go to step 6.

TUNER AM: tunes into a specified preset AM station.

→ Go to step 6.

1 CD-- 1: plays a disc from a specified track of a specified disc. → Go to step 6.

TAPE: plays a tape in the cassette deck.
→ Go to step 7.

AUX IN: plays an external source. → Go to step 7.

6 When selecting “TUNER FM” or “TUNER AM”

Turn **◀◀ / ▶▶** to select the preset station number, then press **SET/DISPLAY**.

The unit enters volume setting mode.

When selecting “1 CD-- 1”

- 1) Turn **◀◀ / ▶▶** to select the disc number, then press **SET/DISPLAY**.
“SET” appears for 1 second.
- 2) Turn **◀◀ / ▶▶** to set the track number, then press **SET/DISPLAY**.
“SET” appears for 1 second, then the unit enters volume setting mode.

7 Turn **◀◀ / ▶▶** to set the volume level.

- The volume level changes as follows:

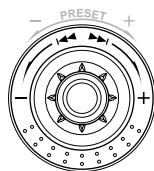
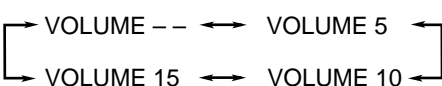

- If you select “VOLUME --,” the volume is set to the last level when the unit has been turned off.

8 Press **SET/DISPLAY** to complete the Daily Timer setting.

The DAILY (Daily Timer) indicator stops flashing and remains lit. “OK ✓” appears on the display for 2 second.

The settings you have done are shown on the display in sequence for your confirmation.

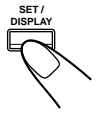

9 Press **⏻/⏻** to turn off the unit (on standby) if you have set the Daily Timer with the unit turned on.

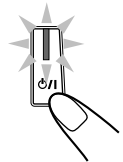

- If the unit is turned on when the on-time comes Daily Timer does not work.
- Even if you unplug the AC power cord or if a power failure occurs

Once you set the timer, the timer setting may remain stored in memory in a few days. In this case, check whether the timer setting still remains or not.

To turn on or off Daily Timer after its setting is done

1 Press **CLOCK/TIMER** repeatedly until “DAILY” appears on the display.



⏻ (Timer) indicator lights up and the DAILY (Daily Timer) indicator starts flashing on the display.

2 To turn off the Daily Timer, press **CANCEL/DEMO**.

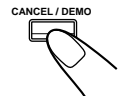

The DAILY (Daily Timer) indicator goes off from the display (“DAILY OFF” appears for a while).

The Daily Timer is canceled, but the setting for the Daily Timer remains in memory.

Or

To turn on the Daily Timer, press **SET/DISPLAY**.

“OK ✓” appears on the display for 2 seconds.

The settings you have done are shown on the display in sequence for your confirmation.

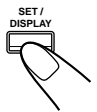

Using Recording Timer

With Recording Timer, you can make a tape of a radio broadcast automatically.

You can set the timer whether the unit is on or off; however, if Ecology Mode is activated, you cannot set the clock while the unit is off.

How Recording Timer actually works

The unit automatically turns on, tunes in to the specified station, sets the volume level to "VOLUME MIN," and starts recording when the on-time comes ("REC" and the REC (Recording Timer) indicator flash just before the on-time, and the REC (Recording Timer) indicator continues flashing while the timer is operating). Then, when the off-time comes ("REC OFF" appears just before the off-time), the unit automatically turns off (on standby).

The timer setting remains in memory until you change it.

- There is a time limit in doing the following steps. If the setting is canceled before you finish, start from step **2** again.
- To correct a mis-entry while setting the timer, press CANCEL/DEMO.

On the unit ONLY:

1 Insert a recordable cassette in with the expose part of the tape down.

2 Press CLOCK/TIMER repeatedly until "REC" appears on the display.

(Timer) indicator lights up and the REC (Recording Timer) indicator also starts flashing on the display.

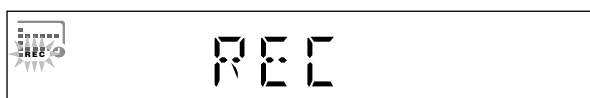

- Each time you press the button, the timer setting modes change as follows:

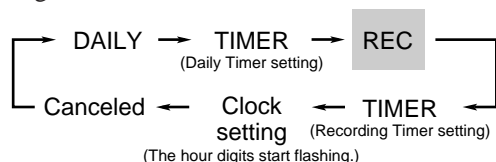

3 Press CLOCK/TIMER again.

"TIMER" appears for 2 seconds, then the unit enters on-time setting mode.

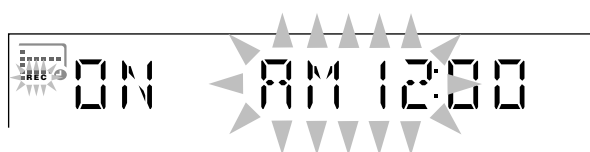

4 Set the on-time you want the unit to turn on at.

- 1) Turn ◀◀ / ▶▶ to set the hour, then press SET/DISPLAY.
"SET" appears for 1 second.
- 2) Turn ◀◀ / ▶▶ to set the minute, then press SET/DISPLAY.
"SET" appears for 1 second, then the unit enters off-time setting mode.

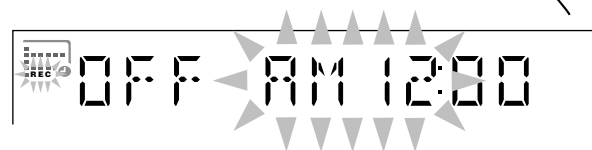
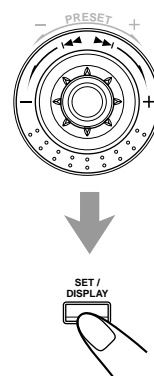

5 Set the off-time you want the unit to turn off (on standby) at.

- 1) Turn ◀◀ / ▶▶ to set the hour, then press SET/DISPLAY.
"SET" appears for 1 second.
- 2) Turn ◀◀ / ▶▶ to set the minute, then press SET/DISPLAY.
"SET" appears for 1 second, then the unit enters preset station selecting mode.

6 Select the preset station.

- 1) Turn ◀◀ / ▶▶ to select the band ("TUNER FM" or "TUNER AM"), then press SET/DISPLAY.
"SET" appears for 1 second.
- 2) Turn ◀◀ / ▶▶ to select a preset channel number, then press SET/DISPLAY.
The REC (Recording Timer) indicator stops flashing and remains lit. "OK ✓" appears on the display for 2 second.
The settings you have done are shown on the display in sequence for your confirmation.

7 Press ⏻/| to turn off the unit (on standby) if necessary.



- If you want to listen to another source while recording Press REC START/STOP or ■ to stop recording. Without stopping it, you cannot change the source.
- Even if you unplug the AC power cord or if a power failure occurs
Once you set the timer, the timer setting may remain stored in memory in a few days. In this case, check whether the timer setting still remains or not.



To turn on or off Recording Timer after its setting is done

1 Press CLOCK/TIMER repeatedly until “REC” appears on the display.

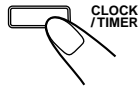

➔ (Timer) indicator lights up and the REC (Recording Timer) indicator starts flashing on the display.

2 To turn off the Recording Timer, press CANCEL/DEMO.

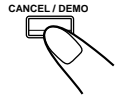

The REC (Recording Timer) indicator goes off from the display (“REC OFF” appears on the display for 2 seconds).

The Recording Timer is canceled, but the setting for the Recording Timer remains in memory.

Or

To turn on the Recording Timer, press SET/DISPLAY.

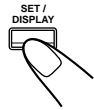

“OK ✓” appears on the display for 2 seconds.

The settings you have done are shown on the display in sequence for your confirmation.

Timer Priority

Since each timer can be set separately, you may wonder what happens if the setting for these timers overlaps.

Below are some examples.

Recording Timer has priority over Daily Timer and Sleep Timer.

- If Daily Timer is set to come on while Recording Timer is operating, Daily Timer will not come on at all.

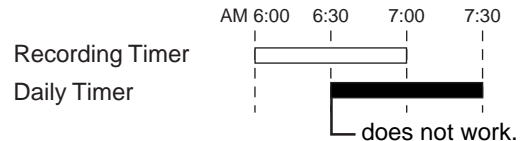

- If Recording Timer is set to come on while Sleep Timer is operating, Sleep Timer will be canceled.

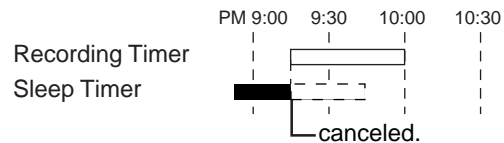

Using Sleep Timer

With Sleep Timer, you can fall asleep to music. You can set Sleep Timer only while the unit is turned on.

How Sleep Timer actually works

The unit automatically turns off after the specified time length passes.

On the remote control ONLY:

1 Press SLEEP.

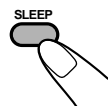

The time length until the shut-off time appears and the SLEEP indicator starts flashing on the display.

- Each time you press the button, the time length changes as follows:

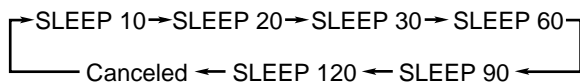

2 Wait for about 5 seconds after specifying the time length.

The SLEEP indicator stops flashing and remains lit.

To check the remaining time until the shut-off time, press SLEEP once so that the remaining time (minute) until the shut-off time appears for about 5 seconds.

To change the shut-off time, press SLEEP repeatedly until the desired time length appears on the display.

To cancel the setting, press SLEEP repeatedly so that the SLEEP indicator goes off.

- Sleep Timer is also canceled when you turn off the unit.

Maintenance



To get the best performance of the unit, keep your discs, tapes, and mechanism clean.

General Notes

In general, you will have the best performance by keeping your discs and the mechanism clean.

- Store discs in their cases, and keep them in cabinets or on shelves.
- Keep the unit's disc trays closed when not in use.

Handling discs



- Remove the disc from its case by holding it at the edge while pressing the center hole lightly.
- Do not touch the shiny surface of the disc, or bend the disc.
- Put the disc back in its case after use to prevent warping.

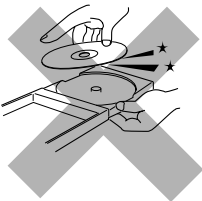

- Be careful not to scratch the surface of the disc when placing it back in its case.
- Avoid exposure to direct sunlight, temperature extremes, and moisture.



- To clean the disc**
Wipe the disc with a soft cloth in a straight line from center to edge.



DO NOT use any solvent—such as conventional record cleaner, spray, thinner, or benzine—to clean the disc.

Handling cassette tapes

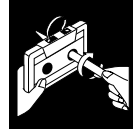

- If the tape is loose in its cassette, take up the slack by inserting a pencil in one of the reels and rotating.
- If the tape is loose, it may get stretched, cut, or caught in the cassette.



- Be careful not to touch the tape surface.



- Avoid the following places to store the tape:
 - In dusty places
 - In direct sunlight or heat
 - In moist areas
 - Near a magnet

Cleaning the unit

• Stains on the unit

Should be wiped off with a soft cloth. If the unit is heavily stained, wipe it with a cloth soaked in water diluted neutral detergent and wrung well, then wipe clean with a dry cloth.

• Since the unit may deteriorate in quality, become damaged or get its paint peeled off, be careful about the followings.

- DO NOT wipe it with a hard cloth.
- DO NOT wipe it strong.
- DO NOT wipe it with thinner or benzine.
- DO NOT apply any volatile substance such as insecticides to it.
- DO NOT allow any rubber or plastic to remain in contact with it for a long time.

Troubleshooting



If you are having a problem with your unit, check this list for a possible solution before calling for service. If you cannot solve the problem from the hints given here, or the unit has been physically damaged, call a qualified person, such as your dealer, for service.

	Symptom	Cause	Action
GENERAL	Unable to cancel the demonstration.	The button other than CANCEL/DEMO is pressed to cancel the display demonstration temporarily.	Press CANCEL/DEMO on the unit. (See page 8.)
	No sound is heard.	Connections are incorrect or loose.	Check all connections and make corrections. (See pages 6 to 8.)
	Operations are disabled.	The built-in microprocessor may malfunction due to external electrical interference.	Unplug the AC power cord and then plug it back in.
	Unable to operate the unit from the remote control.	<ul style="list-style-type: none"> The path between the remote control and the remote sensor on the unit is blocked. The batteries are exhausted. 	<ul style="list-style-type: none"> Remove the obstruction. Replace the batteries.
TUNER	Hard to listen to broadcasts because of noise.	<ul style="list-style-type: none"> Antennas are disconnected. The AM loop antenna is too close to the unit. The FM antenna is not properly extended and positioned. 	<ul style="list-style-type: none"> Reconnect the antennas correctly and securely. Change the position and direction of the AM loop antenna. Extend the FM antenna at the best position.
	CD	The disc sound is discontinuous.	The disc is scratched or dirty.
The disc tray does not open or close. The disc does not play.		<ul style="list-style-type: none"> The AC power cord is not plugged in. Trays are locked. The disc is placed upside down.	<ul style="list-style-type: none"> Plug the AC power cord. Unlock the trays. (See page 17.) Place the disc with the label side up.
TAPE	The cassette holders cannot be opened.	Power supply from the AC power cord has been cut off while the tape was running.	Turn on the unit.
REC	Impossible to record.	Small tabs on the back of the cassette are removed.	Cover the holes with adhesive tape. (See page 19.)

Specifications

Amplifier section—CA-HXZ1

Output Power

SUBWOOFERS: 130 W per channel, min. RMS, driven into 6 Ω at 63 Hz with no more than 10% total harmonic distortion.

MAIN SPEAKERS: 55 W per channel, min. RMS, driven into 6 Ω at 1 kHz with no more than 10% total harmonic distortion.

Audio input sensitivity/Impedance

(Measured at 1 kHz, with tape recording signal 300 mV)

AUX: 390 mV/50 k Ω

Digital output: CD OPTICAL DIGITAL OUTPUT

Signal wave length: 660 nm

Output level: -15 dBm to -12 dBm

Speakers/Impedance:

SUBWOOFERS: 6 Ω – 16 Ω

MAIN SPEAKERS: 6 Ω – 16 Ω

Tuner

FM tuning range: 87.5 MHz – 108.0 MHz

AM tuning range: 530 kHz – 1 710 kHz

CD player

CD capacity: 3 CDs

Dynamic range: 85 dB

Signal-to-noise ratio: 90 dB

Wow and flutter: Immeasurable

Cassette deck

Frequency response

Normal (type I): 50 Hz – 14 000 Hz

Wow and flutter: 0.15% (WRMS)

General

Power requirement: AC 120 V \sim , 60 Hz

Power consumption: 165 W/210 VA (at operation)

24 W (on standby with Ecology Mode off)

1.3 W (on standby with Ecology Mode on)

Dimensions (approx.): 205 mm x 370 mm x 370 mm (W/H/D)

(8¹/₈ in. x 14⁵/₈ in. x 14⁵/₈ in.)

Mass (approx.): 10.0 kg (22.1 lbs)

Supplied accessories

See page 6.

Speaker section—SP-HXZ1

Type: 3-Way 4-Speaker Bass-Reflex Type Twin Hyper Power-Drive Subwoofers and Front Twin Woofer

Speaker units: Subwoofer: 16 cm (6⁵/₁₆ in.) cone x1
Woofer: 10 cm (3¹⁵/₁₆ in.) cone x2
Tweeter: 5 cm (2 in.) cone x1

Power handling capacity: Subwoofer: 130 W

Main speaker: 55 W

Impedance: Subwoofer: 6 Ω

Main speaker: 6 Ω

Frequency range: Subwoofer: 30 Hz – 120 Hz

Main speaker: 75 Hz – 32 000 Hz

Sound pressure level: Subwoofer: 78 dB/W•m

Main speaker: 86 dB/W•m

Dimensions (approx.): 217 mm x 432 mm x 365 mm (W/H/D)
(8⁹/₁₆ in. x 17¹/₁₆ in. x 14³/₈ in.)

Mass (approx.): 7.6 kg (16.8 lbs) each

Design and specifications are subject to change without notice.



JVC
VICTOR COMPANY OF JAPAN, LIMITED

NOTICE/ AVIS

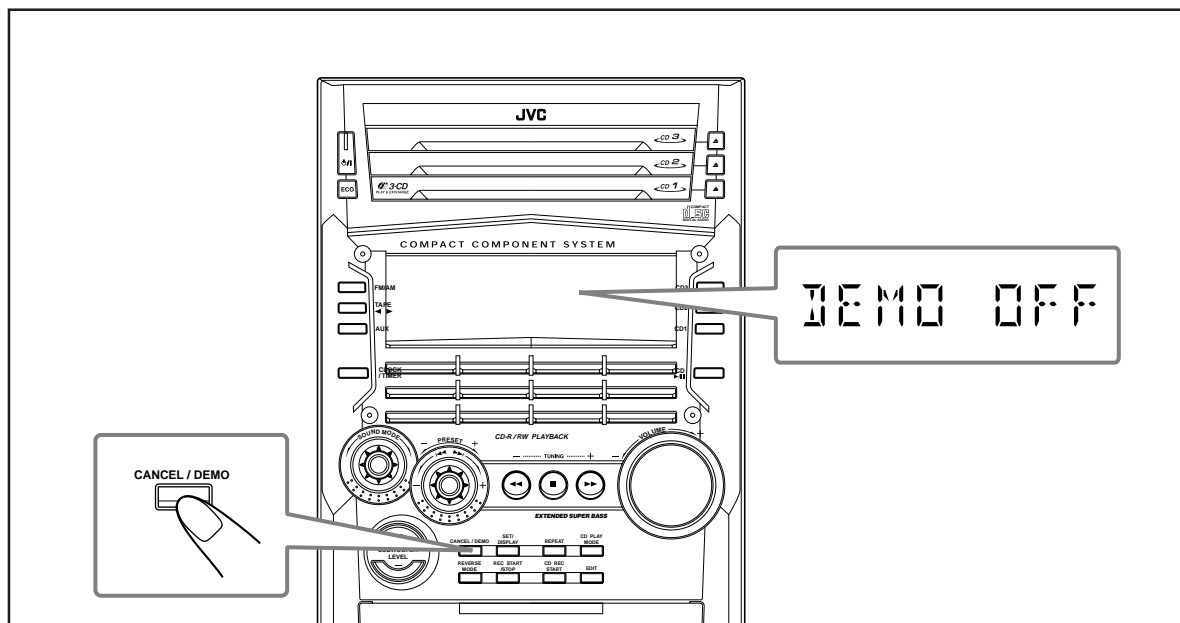

English

Demonstration

When connecting the AC power cord into a wall outlet, the unit automatically starts the demonstration.

To cancel the demonstration, press and hold CANCEL/DEMO until “DEMO OFF” appears on the display.

- For more detailed information about the demonstration, refer to the Instructions manual on page 8.

Français

Démonstration

Quand vous connectez le cordon d'alimentation secteur sur une prise secteur murale, l'appareil commence automatiquement de démonstration.

Pour annuler la démonstration, maintenez pressée CANCEL/DEMO jusqu'à ce que “DEMO OFF” apparaisse sur l'affichage.

- Pour plus d'informations à propos de la démonstration, référez-vous à Manuel d'instructions aux page 8.